

Time to Wake Up Not Woke Up

Principal Officer A.C.T. Judicial Council Principal.Officer@actjudicialcouncil.org.au
Senate Standing Committees on Legal and Constitutional Affairs legcon.sen@aph.gov.au
JOINT SELECT COMMITTEE ON AUSTRALIA'S FAMILY LAW SYSTEM familylaw.sen@aph.gov.au

Protections Unit Protection@courts.act.gov.au
Mary Toohey - Parliamentary Council - pco@act.gov.au
A.C.T. Ombudsman Ombudsman North Ombudsman.North@ombudsman.gov.au
Human Rights ACT Dr Helen Watchirs OAM, ACT President and Human Rights Commissioner
Human_Rights@act.gov.au

A.C.T. Legislative Assembly

Andrew Barr barr@act.gov.au

Senators & Committees

Senator the Hon Alex Antic senator.antic@aph.gov.au
Senator the Hon Eric Abetz senator.abetz@aph.gov.au
Senator the Hon Simon Birmingham senator.birmingham@aph.gov.au
Senator the Hon Andrew Bragg senator.bragg@aph.gov.au
Senator the Hon Slade Brockman senator.brockman@aph.gov.au
Senator the Hon Matthew Canavan Senator.Canavan@aph.gov.au
Senator the Hon Michaelia Cash senator.cash@aph.gov.au
Senator the Hon Claire Chandler senator.chandler@aph.gov.au
Senator the Hon Richard Colbeck senator.colbeck@aph.gov.au
Senator the Hon Concetta Fierravanti-Wells senator.fierravanti-wells@aph.gov.au
Senator the Hon Alex Gallacher senator.gallacher@aph.gov.au
Senator the Hon Katy Gallagher senator.katy.gallagher@aph.gov.au
Senator the Hon Sarah Hanson-Young senator.hanson-young@aph.gov.au
Senator the Hon Sarah Henderson senator.henderson@aph.gov.au
Senator the Hon Hollie Hughes senator.hughes@aph.gov.au
Senator the Hon Jane Hume senator.hume@aph.gov.au
Senator the Hon Kristina Keneally senator.keneally@aph.gov.au
Senator the Hon Jacqui Lambie senator.lambie@aph.gov.au
Senator the Hon Sue Lines senator.lines@aph.gov.au
Senator the Hon Jenny McAllister jennifer.mcallister@aph.gov.au
Senator the Hon Malarndirri McCarthy Senator.McCarthy@aph.gov.au
Senator the Hon Susan McDonald senator.mcdonald@aph.gov.au
Senator the Hon James McGrath senator.mcgrath@aph.gov.au
Senator the Hon Bridget McKenzie senator.mckenzie@aph.gov.au
Senator the Hon Nick McKim senator.mckim@aph.gov.au
Senator the Hon Andrew McLachlan CSC senator.Mclachlan@aph.gov.au
Senator the Hon Sam McMahon senator.mcmahon@aph.gov.au
Senator the Hon Jim Molan AO DSC senator.molan@aph.gov.au
Senator the Hon Deborah O'Neill senator.oneill@aph.gov.au
Senator the Hon Matt O'Sullivan senator.matt.o'sullivan@aph.gov.au
Senator the Hon James Paterson senator.paterson@aph.gov.au
Senator the Hon Rex Patrick senator.patrick@aph.gov.au
Senator the Hon Marise Payne senator.payne@aph.gov.au , ministerforwomen@pmc.gov.au
Senator the Hon Helen Polley senator.polley@aph.gov.au

Time to Wake Up Not Woke Up

Senator the Hon Louise Pratt senator.pratt@aph.gov.au
Senator the Hon Linda Reynolds CSC senator.reynolds@aph.gov.au
Senator the Hon Janet Rice senator.rice@aph.gov.au
Senator the Hon Anne Ruston senator.ruston@aph.gov.au
Senator the Hon Zed Seselja senator.seselja@aph.gov.au
Senator the Hon Tony Sheldon senator.sheldon@aph.gov.au
Senator the Hon Peter Whish-Wilson senator.whish-wilson@aph.gov.au
Senator the Hon Penny Wong senator.wong@aph.gov.au

Various Politicians

Anthony Albanese MP A.Albanese.MP@aph.gov.au
Andrew Leigh MP Andrew.Leigh.MP@aph.gov.au
Alicia Payne MP Alicia.Payne.MP@aph.gov.au
Terri Butler (MP) Terri.Butler.MP@aph.gov.au
Graham Perrett MP Graham.Perrett.MP@aph.gov.au
Littleproud, David (MP) David.Littleproud.MP@aph.gov.au
Hon Christian Porter MP christian.porter.mp@aph.gov.au
Dan Tehan MP Dan.Tehan.mp@aph.gov.au
Hon Mark Butler MP mark.butler.mp@aph.gov.au
Hon Mark Dreyfus QC, MP mark.dreyfus.mp@aph.gov.au
Dr Jim Chalmers MP jim.chalmers.mp@aph.gov.au

ABC

ABC Email: managingdirectorsoffice@abc.net.au
Troy Cuthbertson cuthbertson.troy@abc.net.au

Copies to:

Senator the Hon Amanda Stoker senator.stoker@aph.gov.au
Linda Burney MP Linda.Burney.MP@aph.gov.au
Senator the Hon Pauline Hanson senator.Hanson@aph.gov.au
Senator the Hon Malcolm Roberts senator.roberts@aph.gov.au
The Hon. Mark Latham, MLC mark.latham@parliament.nsw.gov.au
Former Senator David Leyonhjelm <https://davidleyonhjelm.com.au/> info@davidleyonhjelm.com.au
Elizabeth Kirkkert KIKKERT@parliament.act.gov.au
Bettina Arndt Bettina@bettinaarndt.com.au
Michael Inman Inman.Michael@abc.net.au
ABC Friends office@abcfriends.org.au
ACT Law Society nicole.karman@actlawsociety.asn.au
J Maley jmaley@smh.com.au
yoursay@skynews.com.au
Craig Kelly craig.kelly.mp@aph.gov.au
Michael McCormack michael.mccormack.mp@aph.gov.au
Peter Cain CAIN@parliament.act.gov.au
boltreport@skynews.com.au

Jonathan Pearson Humanistman.com

Contents

<i>Preamble - (from previous correspondence)</i>	4
So Here we Are	5
Free Speech - Independent Media - Impartial - Causes.....	9
Tribal Bigotry Destroys Other Nations.....	13
Sacrificing Expensive Chickens For Things Not Understood	23
The Nation Experiment	24
Trust is Destroyed	25
Tyrannical Dictators Psychopaths Extremists	27
A Rush to Principle	29
The Violence of the Smuglifunts	33
Ungrateful Entitled Victims - Feminists	34
A Brief History of Public Service and how to destroy it.....	38
The Gift of the Virtue Prayer.....	49
The Case of the Next BLACK FEMALE judge.....	49
Framing Shaming Avoiding and Abusing.....	53
A culture of false or improvable allegations.....	62
Tribal Entitled/Victim Groupthink Focus destroys Nations	63
Positioning For Violence and Control	64
Abstraction - Zoom - Granularity - Avoiding the Binary Certain Dogma	65
Chronicles from the End of Civilization.....	69
Recent Documents.....	69
Recent People	72
References	72

I respect you too much not to have this argument – Author(Jonathan Pearson) Year[2019]

:Keywords(Development Agree Individual)

“Evil comes from a failure to think. It defies thought for as soon as thought tries to engage itself with evil and examine the premises and principles from which it originates, it is frustrated because it finds nothing there. That is the banality of evil.” – Author(Hannah Arendt) Year[1963]

Source_Document(*Eichmann in Jerusalem. A Report on the Banality of Evil*) :Keywords(Choice

Responsibility Individual) <https://www.newyorker.com/magazine/1963/02/16/eichmann-in-jerusalem-i>
https://platypus1917.org/wp-content/uploads/2014/01/arendt_eichmanninjerusalem.pdf

3 years into emergency laws, lock downs, mandates and rule by daily decree by insane politicians and bureaucrats. Tyrants, dictators and their sycophantic mob supporters - pedaling hatred, groupthink, abuse and demonization of “others”, pig-ignorance, virtue signaling and incoherence.

This is what I wrote and sent to many of you some time ago

Preamble - (from previous correspondence)

*The issues I raise are directly relevant to the standing senate committees on legal and constitutional affairs, the family law, the senate’s powers over the courts in Australia and for those Senators and other parliamentary committee members who express an interest in “domestic violence” – as they use the term. The corruption and lies are now widespread. **Interim Domestic orders are made immediately against men** – without notification and **can never be revoked**. These are **directly referred to** in many other legislation – including the Family Law Act 1975 as relevant – specifically to address assets, children and other matters **directly beneficial to women making allegations**.*

*There has been a deliberate **ongoing strategy** to corrupt the judicial process, justice and **criminalize all boys and men** by feminists, legislators and other extremists working in the public service, human rights committees, courts, politicians and the media at large. Women lawyers and feminist women generally will do or say anything to corrupt the system, attack men and gain money and advantage for themselves.*

***All of you are involved in this corruption and lies** and keep doubling down and abusing people who dare to point it out and raise attention to the issues. Whistle blowers are jumped on from great heights. Police violently attack people for “resisting arrest” and “assaulting Police” – **you are** the totalitarian corrupt regime.*

Every piece of legislation, every appointment is designed to put in place - either in plain sight or as a Trojan Horse – aspects and features to further the “ideologists” cause. E.g. Gay Marriage legislation in the A.C.T is used to undermine not only the marriage Act but also Family Law (as corrupt as that is) with ever more corruptions and advances for the “feminist cause” – more money, more court cases, etc.

Ramsay refused to answer any questions he told me to get a judicial review. So here we are – many letters and emails later.

Don’t for a moment think that the brutality you are starting to notice around the place is a recent phenomenon. 70 years of entrenched corruption – slowly builds up. No consequences for liars and abusers. Mob mentality and smug self-righteous vigilantism. #Me always.

Note – for example – the ACT Human Rights Commissioner - Helen Watchirs - declares A.C.T. Domestic Violence Law is consistent with Human Rights. i.e. orders made immediately on application by a woman – man never able to defend himself, orders made –ex-parte and permanent record never able to be revoked. And then she doubles down – sends her staff to the Family Law Enquiries to help corrupt federal

law and signs a letter about women being victims. <https://humanistman.com/wp-content/uploads/2020/07/Women-Lawyers-Corruption-Feminism-Debate.pdf> The full circle of conspiracy and corruption has been operating for some time now as most of you know. But you are full of and surrounded by corruption and lies yourself so **you no longer notice**. As if you ever cared.

So Here we Are

No politician will engage with the issues I raise or acknowledge I exist. Delusional psychopaths. See **Obvious Deluded Psychopaths - Extremists - Feminists** <https://humanistman.com/wp-content/uploads/2022/01/Obvious-Deluded-Psychopaths-Extremists-Feminists.pdf>

'Ye flee from me? Ye are frightened? Ye tremble at this word?' - Author(**Friedrich Wilhelm Nietzsche**) Year[1891] Source_Document(**Thus Spake**

Zarathustra) Keyword(Humanism Communicate Group) <http://www.gutenberg.org/files/1998/1998-0.txt>

This **widespread deluded lies and corruption goes world-wide**. The elites refuse to communicate and cooperate with the population. They **refuse to learn and develop**. They stay stuck in their smug complacency and corruption - their corrupt and smug tribes. Ex politicians become board members and ambassadors. Politicians, Public Servants, Media, Police, Legal community - the highly paid commissioners, board members and business elites - all cooperating and hiding information - distracting the population and keeping the wheels of corruption and propaganda operating smoothly - graft, gifts, bribes, donations, promises, expectations, Bags of Cash "Donations" - "this is the way we do things around here" - Not only China but Russia, Canada, Australia, USA, North Korea and all the dictatorships and tyrannies throughout history - using the police, army, propaganda and social controls to control the population and enrich themselves.

See the history of the world. [Learn](#).

Messages <https://humanistman.com/home/humanism/messages/>

People <https://humanistman.com/home/humanism/people/>

Documents <https://humanistman.com/home/humanism/documents/>

World Map Context

https://www.google.com/maps/d/embed?mid=1dlgz_4B5_uqCAHD4SoJKGaPgRW69WByi

Everyone reviews themselves or their friends and determines that, yea verily, they are extremely good under the circumstances. When people start noticing or the population becomes restless - idiots call for a "Royal Commission" - not only to further employ the corrupt legal class, but to obfuscate and hide blatant corruption and lies. They appoint themselves and friends to be "Royal Commissioners" - they get even more public money. To ask "the right" questions - "thanks for that question - I'm glad you asked me that" or "I don't recall, I wasn't there, I refuse to answer on the grounds that it might incriminate

me” - “you are not authorized to ask questions”. **A show - a play - a performance piece by trained narcissistic liars and bullshitters.**

Andrew Barr - like all the A.C.T. public servants - refuses to answer any questions. They ignore everyone - not only me - but anyone who dares to ask. Andrew Barr showers Gordon Ramsay in public service money as a personal favor when Ramsay fails to get re-elected - the corrupt look after each other using the public money. Ex-Politicians get public service jobs or Board positions with friendly companies. *They all do it - it is the way we do things around here* - they say to each on the race to the bottom. As we see from all the political class - they are corrupt, fail to tell the whole truth (liars) and mostly incompetent - they lack intelligence, ability and interest in learning or improving - they are pig-ignorantly determined to fail to develop and hence double down on their smug certainty.

We know that the intelligentsia is gone because they are cancelled and jumped on if they ask questions and threaten the corruption. Daring to question is a crime worthy of government sanction and political expulsion. See Bettina Arndt being sanctioned by the Australian senate for daring to repeat a question in public (The senate **calling to arms** the **vigilante violent extremist feminist mobs** to attack individuals - if the senate were Donald Trump they would already be tried and executed for their crimes).

University professors who dare to ask are cancelled. Employees who dare to question and point out the corruption are sacked or jailed in secret. “Don’t make corruption a public issue - it would not be in the “National Interest” to know how corrupt we are - it would threaten “National Security” if the truth was known. It is not in the “Public Interest” to know how biased and corrupt the ABC is - says David Anderson - *we prefer to run our own corrupt agenda - anyway, our complaints department has handled all complaints and if that is not enough then spend the rest of your life complaining to every level of the public service or take us to court* - a perfect solution for everyone isn’t it? A win/win for the elites.

See **What am I missing** (2 articles) <https://humanistman.com/wp-content/uploads/2021/09/What-Am-I-Missing.pdf> , <https://humanistman.com/wp-content/uploads/2021/11/What-Am-I-Missing-to-1300-continued.pdf>

The populace sees all the corruption and say “what can you do?” The Greens and other binary types tend to actively join in the mob like violence and corruption game for their “**certain cause**” - working with corrupt system rather than trying to fix corruption. I know - they say - “let us have a royal commission into corruption or appoint a permanent royal commissioner” - completely oblivious to the warnings of Orwell and the message of his writings or the **lessons of history**. I know, let us have a “Human Rights Commission” a “Truth Commission” a “Final Judgement Commission” a “dogmatic binary certain truth commission” - “A certain diversity measurement commission” - “A reconciliation commission” - “An office for certain women victims” - they could never become corrupt could they? It is all very, very good and the right thing to do isn’t it?

“Power Corrupts” (Lord Acton) - The ends learns to justify the means.

“You can’t make an omelette without breaking some of your neighbours eggs” (me, here, now)

It is obvious isn't it?

See **12 Humanism – Corruption – Hypocrisy, Version 1, date 18/06/2019**

<https://humanistman.com/wp-content/uploads/2019/06/11-Humanism-Corruption-Hypocrisy.pdf> , 15

Humanism – Corruption – Nation Choice – Virtue, Version 1, date 03/04/2020

[https://humanistman.com/wp-content/uploads/2020/04/15-Humanism-Corruption-Nation-Choice-](https://humanistman.com/wp-content/uploads/2020/04/15-Humanism-Corruption-Nation-Choice-Virtue.pdf)

[Virtue.pdf](https://humanistman.com/wp-content/uploads/2020/01/Corruption-Measurement-and-Implementation.pdf) , **Corruption – Measurement and Implementation** <https://humanistman.com/wp-content/uploads/2020/01/Corruption-Measurement-and-Implementation.pdf> , **Corruption – Extremists**

<https://humanistman.com/wp-content/uploads/2020/01/Corruption-Extremists-Feedback.pdf>

The legal class is fully corrupt - not just the feminists but all of the narcissists and deluded psychopaths. See the A.C.T. Magistrates court (White Ribbon Cause) and my case (Soon to be a major investigation by the ABC into their own corruption as well (a little joke)). The legal scum of society.

See **Women Lawyers – Corruption – Feminism – Debate** <https://humanistman.com/wp-content/uploads/2020/07/Women-Lawyers-Corruption-Feminism-Debate.pdf>

When you are at war you **chose to see** who the victims are - Your tribe and friends and family are the victims and everyone else is the perpetrator - in a binary kind of way. *"I had to defend myself"* they scream as they attack you in a full on assault. The **passive aggressive** - I had no other choice than to be corrupt, delusional and a narcissistic psychopath. I love myself and my tribe. Binary.

See **Corruption – Binary Thinking – Prove You are Not A Criminal** <https://humanistman.com/wp-content/uploads/2020/07/Corruption-Binary-Thinking-Prove-You-are-Not-A-Criminal.pdf> and **Stepping Over The Bodies With Binary Certainty** <https://humanistman.com/wp-content/uploads/2021/02/Stepping-Over-The-Bodies-With-Binary-Certainty.pdf>

Binaries love their certainty and the entitled victim game - in a violently passive aggressive way or smug self-righteous hero or both. It is their habit.

See **Binary Groupthink** <https://humanistman.com/wp-content/uploads/2020/06/Binary-Groupthink.pdf> , **Time Reaction Pattern Habit Plan** <https://humanistman.com/wp-content/uploads/2021/05/Time-Reaction-Pattern-Habit-Plan.pdf>

The Corrupt, Binary certain extremists, feminists, women (on average - isn't about time we had a biased, groupthink, women prime minister, high court judge?) and weak minded men - hate questions, hate learning, hate developing - because they are all fully developed - are they not? Nothing to learn here. I know all about life.

See **Observe - The Fool and The Expert** <https://humanistman.com/wp-content/uploads/2019/09/Observe-The-Fool-and-The-Expert.pdf> and **Debates - Human Difficulties** <https://humanistman.com/wp-content/uploads/2019/10/Debates-Human-Difficulties.pdf>

Weak minded men get easily framed into binary certainty by victim causes. **"Either be my certain hero for my certain cause or you are the perpetrator."** Take certain action now!

See **Gender** <https://humanistman.com/wp-content/uploads/2021/06/Gender.pdf> , **13 Humanism – Activation, Version 1, date 30/09/2019** <https://humanistman.com/wp-content/uploads/2019/09/13-Humanism-Activation.pdf>

It is clearly insane and corrupt to value and measure public service jobs based on gender and identity.

The obvious **feminist bigotry, bias, nepotism** and other corruption throughout political, legal, education, police, media, business, charities and public services AS LEGISLATED goes completely ignored - indeed, **CHEERED ON** by all and sundry - **mobs** and delusional psychopaths.

D-I-E MUST DIE (Jordan Peterson)

<https://www.youtube.com/watch?v=oq2rBE5zwAs>

Everyone **loves to have** a **certain answer to all problems and issues** “Just make it (life itself) go away” say the nihilists, feminists, binary extremists, communists, socialists, Religious Zealots, weak minded men “Certain Utopian Heaven NOW!” they demand with screeching loud hailer provided by the ABC and politicians. **KEEP ME SAFE FROM LIFE ITSELF**

*'no longer to **thrust one's head into the sand of celestial things**, but to carry it freely, a terrestrial head, which giveth meaning to the earth!' - Author(Friedrich Wilhelm Nietzsche) Year[1891]*

Source_Document(Thus Spake Zarathustra) Keyword(Humanism Observe Individual)

<http://www.gutenberg.org/files/1998/1998-0.txt>

See **9. Equality and Diversity** <https://humanistman.com/wp-content/uploads/2019/03/07-Humanism-Meta-Frame-Equality-and-Diversity.pdf> **Optimizing Between Extreme Distributions – Social Justice** <https://humanistman.com/wp-content/uploads/2020/07/Optimizing-Between-Extreme-Distributions-Social-Justice.pdf> , **Why Not A Humanist Manifesto** <https://humanistman.com/wp-content/uploads/2021/08/Why-Not-A-Humanist-Manifesto.pdf>

Free Speech - Independent Media - Impartial - Causes

"At the heart of the First Amendment is the recognition of the fundamental importance of **the free flow of ideas and opinions on matters of public interest and concern**. The freedom to speak one's mind is not only an aspect of individual liberty – and thus a good unto itself – but also is essential to the **common quest for truth and the vitality of society as a whole**. We have therefore been particularly vigilant to ensure that individual expressions of ideas remain **free from governmentally imposed sanctions**." - **Hustler Magazine v. Falwell - United States Supreme Court'** - Author(**United States Supreme Court**) Year[1988] Keyword(Humanism Truth Group)

https://en.wikipedia.org/wiki/Hustler_Magazine_v._Falwell | <https://www.thefire.org/first-amendment-library/decision/hustler-magazine-and-larry-c-flynt-v-jerry-falwell/>

<https://www.dailymail.co.uk/news/article-10575485/Sasha-Gillies-Lekakis-slams-Stan-Grant-booted-ABC-Q-Ukraine-Russia-question.html> Typical of the ABC last night - having invited a debate about the invasions of Ukraine by Russia - then asked audience participants who supported Russia to leave the debate. How can you **learn** anything if you don't hear the arguments and understand the issues? How can you learn to debate unless you are confronted with alternative idiotologies and ideas and then have to find within yourself the sensible and reasonable argument to counter their narrative?

The REASON you LISTEN to alternative IDEAS is to try to construct the sensible argument AROUND IT - not necessarily binary but POSSIBLY FOR or AGAINST. This is why you read books from a variety of authors and places. You don't argue with a Volcano - but you do **try to understand** it and the messages it is giving you. Leave the room, volcano!

Of course, Stan Grant, as a designated *blackfella*, a **designated entitled victim** - fills himself with smug unction and demands that the man who questions must leave the debate. - calling on the mob vigilantes to support him. Stan, like most of the feminists and weak minded men at the ABC, are completely oblivious to his own behaviour and ignorance. **They are too stupid to know how stupid they are.** Stan the Hero (using abuse and smug violence - smuglifuntism) and Stan the Designated Victim (*blackfella - always was and always will be "first nations"* (not tribes - they have a NATIONAL FLAG don't you know?) country) - occupying two positions of the binary Drama Triangle simultaneously.

But of course the bigoted, tribal, victim narrative is run by all governments in Australia "Keeping Women and THEIR children safe", "respect" and the "Calling it out" register - where allegations become "facts" and "feelings" become reason - the bigots are everywhere - the tribes corrupting all levels of government. SBS, ABC - all tribal. Land, media, government services - money, money, whinge, complain, money for the binary, weak-minded, hate-filled bigots - they are rewarded the more they complain and whinge. Corrupt politicians everywhere, lies, bullshit and hero/victim narrative.

A **dearth of intellect**, knowledge of history and courage.

Feminists, Binary extremists, women (on average - quotas, etc) and weak minded men - everywhere. Andrew Barr ignores me, Andrew Leigh fills himself with smuglifuntism as he attacks me in public, A.C.T. Magistrate Robert Cook (the complete narcissist - as all the Magistrates tend to be) - personally

outraged at having to read documents and listen to a defense having already decided that women are victims and that all men are perpetrators (as the white ribbon cause - inserted as policy into the public service, education and justice departments world wide) insists in judging me guilty before a trial (like the domestic violence laws in the A.C.T. demand - guilty without a trial or being aware of the charges or complaints) , Deputy Registrar Edwards - all these magistrates full of themselves, their binary drama triangle judgement - Bernadette Boss - who threatened me - A.C.T. Chief Magistrate Lorraine Walker who can't believe women lie (mentally ill women/evil men) "Women are victims" (That's what the courts and legal system is for) "Kill all men" - the feminist motto run by women everywhere. All the staff, registrars and public servants - Ombudsman North - Refuses to investigate - the judicial review team **refuse to answer** or investigate - Edwards is not able to be investigated because he operates outside the general law - he has been exempted from review. Politicians like Ramsay, all the women in the Legislative assembly - all the feminists - All the Labour Party and Greens of course and many of the Liberals - Tanya Plibersek attacks Craig Kelly for daring to ask, Penny Wong attacks everyone all the time "small men speech" (women (only Labour Party Women now) are the "**real**" **victims** declares (*I'm not a bully*) Penny) - demonization, **groupthink dominating their bigoted lives** as they parade themselves as heroes for the "cause" - the virtue signaling binary drama triangle of violence instigated by the "passive" aggressive - *I had to defend myself by attacking you first. Leave the room, stop questioning, stop seeking explanations, **stop upsetting my smug delusions.***

60% women up from 40% in the public service IS DEFINED AS EQUALITY (now defined as "equity"). Diversity is 90% women in the public service (EVEN BETTER - MORE GOODNESS - more "inclusion") - all promoting themselves all the time supported by weak minded virtue signaling men as all skills and capabilities are degraded and lost to be replaced by **certain IDENTITY**. *What work did you do today? I can't tell you but I can't tell you that **we** (the mob) are all nearly black women now.*

Kamala Harris - a Black women promoted to Vice President of USA - "*Gosh, this is serious stuff now in Ukraine - you know - it might even lead to war*" "*Russia is a big country and Ukraine is small country next to it*". Proudly displaying the benefits of having promoted someone based on identity or mob popularism.

QUOTAS for all jobs - politics, law, courts (isn't good we have a Gay, Female, Black, Transgender high court judge - inclusive), universities - more blacks (oops - "first Nations") more women with free education support, housing and money (the Family law and CSA systems are not corrupt enough it seems for the virtue signalers).

Constant groupthink, division and delusional bigotry - see how GOOD I AM? My Goodness knows no bounds - the world itself will suffer from my **BIG RED BUTTON OF CERTAIN GOODNESS**.

Booing virtue signalling "Sportsmen" - cricketers and footballers as they **TAKE THE KNEE, WAVE THE FLAG** to **THE CERTAIN CAUSE** is real and not understood - even by those booing. Humans know that seems wrong but they do not really understand why. (Brendan O'Neill gets it now) Stephen Price knew that the NZ feminist virtue signaling prime minister seemed wrong but he could not explain it. The **Mob shamed him** so he had to apologize. "**Take the Knee!**" - the mob demands. *"Isn't about time you*

*apologized for everything” - says the ABC - Laura Tingle to the Prime Minister at the Press Club. Mobs do that - they are the binaries who **refuse to debate** (Feminists, Religious Zealots, Binaries, Weak Men, Stan Grant and the ABC mobs)*

John Cleese is calling out the madness now more strongly and being attacked by the women and weak minded men. <https://www.dailymail.co.uk/news/article-10606743/John-Cleese-stuns-South-Southwest-crowd-jokes-historic-slave-reparations-Britain.html?fbclid=IwAR0biL13HHc9w3cJAPfr7FvbV7tHhloFJLzNVBYMnvCvJUj-wGSYC4wUhYc>

I explained virtue signaling here **15 Humanism – Corruption – Nation Choice – Virtue, Version 1, date**

03/04/2020 <https://humanistman.com/wp-content/uploads/2020/04/15-Humanism-Corruption-Nation-Choice-Virtue.pdf> “Each time I start writing a new letter to politicians, courts, media

and others I notice that I need to develop more simple models to help communicate with them. I also notice that that what I am observing in society through media reports is that **corruption is on the**

increase and that the most **corrupt people are doubling down and becoming even more**

aggressive towards anyone who attempts to call out corruption. Throughout the world

nations are starting to crumble around the **corruption, lies, bias and incoherence of governments, corporations, public service, courts and throughout society. Humans who are trying to speak out are being demonized and attacked.** Anything anyone said as a child or did anytime in their life is used to wholly dismiss a person and any ideas they express and deny them any ability to contribute to society. They are de-humanized by the mob”

‘I pass through this people and keep mine eyes open; they have become SMALLER, and ever become smaller:—THE REASON THEREOF IS THEIR DOCTRINE OF HAPPINESS AND VIRTUE.’ :Author(**Friedrich Nietzsche**) :Year(1891) :Source Document(Thus Spake Zarathustra) :Keyword(Choice)

<http://www.gutenberg.org/files/1998/1998-0.txt>

<https://www.ag.gov.au/rights-and-protections/human-rights-and-anti-discrimination/human-rights-scrutiny/public-sector-guidance-sheets/right-freedom-opinion-and-expression> “The right to freedom of opinion is the right to hold opinions without interference, and **cannot be subject to any exception or restriction.** The right to freedom of expression extends to any medium, including written and oral communications, **the media, public protest,** broadcasting, artistic works and commercial advertising. The right is not absolute. It carries with it special responsibilities, and **may be restricted** on **several grounds.** For example, restrictions could relate to filtering access to certain internet sites, the urging of violence or the classification of artistic material.”

https://en.wikipedia.org/wiki/Freedom_of_speech “Justifications for such include the harm principle, proposed by John Stuart Mill in *On Liberty*, which suggests that “the only purpose for which power can be rightfully exercised over any member of a civilized community, against his will, is to **prevent harm to others.**”[4]”

But the **HARM** has been taken by the feminists, extremists, Religious Zealots and other binary extremists to mean **PERSONAL OFFENCE** (18C). This suits the anxiety riddled, narcissistic women, blacks (Entitled victim narrative) and weak minded men - generally poorly educated and determinedly PIG-IGNORANT (George Orwell, Animal Farm) or totally immersed in Propaganda (China, Russia, North Korea and now Australia, Canada, USA and UK). **Children are trained to be offended all the time** and to immediately identify OFFENCE in themselves and by any PERPETRATORS of OFFENCE. The more perpetrators they attack, the **GOODER** they are. (Nazi children) .Feel free to beat yourself up - the mobs demands (as did the Nazis **dehumanized** the Jews as they lead them to death - totally destroying any will to protest, disagree or fight for their own lives)

On Liberty (Rank:10) :Author(**John Stuart Mill**) :Year[1859] Age(53) :Keyword(Individual Philosophy Thinkers Library) <https://www.utilitarianism.com/ol/one.html> <https://rationalist.org.uk/archives>

But **who wants liberty** or **understands the importance of it** when the **preference is to live under totalitarian Rule** - It does not matter who it is or what dogma it is - China, Russia, Tyrants, Dictators, Religious Zealots, Feminists - all the binary certaintists and extremists. All the **delusional sociopathic dictators** see themselves as "Saviours" HALLELUJAH to their fellow chosen humans.

What "good" is freedom, anyway?

HAVE YOU FORGOTTEN HISTORY?

Do YOU KNOW NOTHING?

*"No, you do not have to live as a man; it is an act of moral choice. But you **cannot live as anything else**— and the alternative is that state of living death which you now see within you and around you, the state of a thing unfit for existence, **no longer human and less than animal, a thing that knows nothing but pain and drags itself through its span of years in the agony of unthinking self-destruction.**" -*

Author(**Ayn Rand**) Year[1957] Source_Document(Atlas Shrugged) Keyword(Humanism Morals Individual) <https://www.nationallibertyalliance.org/files/docs/Books/Atlas%20Shrugged.pdf>
https://archive.org/details/Ayn_Rand_Atlas_Shrugged/page/n1/mode/2up

Who judges who is allowed to **speak freely** or not - the ABC? - "**Let's BURN THIS PLACE DOWN - WHO IS WITH ME**" was broadcast by the ABC on a panel discussion. This wasn't cancelled yet anyone daring to question feminists or green narrative is cancelled **all the time**.

But the ABC is a mob based cause media outlet - Feminists, victims and themselves - their virtue in certainty saving the world. David Anderson fills his virtue cup with making sure only the "Right" voices are heard and the "Wrong" ones are ignored or demonized. Smug Certain God of righteousness. The Arbiter (Latin: Arbitrari <https://www.latin-is-simple.com/en/vocabulary/verb/268/>) of "Truth".

Can a Narcissistic Deluded Psychopath running the "cause" ("White Ribbon", Women, feminists, groupthink, black tribe, victim/hero narrative) be considered **compos mentis** ??

https://en.wikipedia.org/wiki/Non_compos_mentis

This is what little children are taught in schools and universities so they can become **hanging judges for the righteous cause** and get their little hands on as many red buttons of certainty they can push - all the time abusing, chortling, lying and laughing (Greens/Labour Party Women (**baby tantrums**) in parliament) at humanity itself while they indulge themselves - their narcissism, greed, virtue and smug corruption - usually while working in public “service” positions in Law, Education, Politics, Charities and all the public services. The Nihilists and Cavaliers of our time. Children are taught to hate, divide, demonize and attack White men and “respect” women.

Most of the press are virtue cause mobs. The National press club stands up and cheers, like a football crowd, the feminist victim narrative, the green virtue narrative, the drama triangle of perpetrator, victim, hero - with themselves the Knights Templar of the righteous cause. Certain Gods with swords.

Children don't believe in free media - they don't know what it means or why some old people even talk about it. They believe in groupthink and demonization of others based on virtue. Tribalism comes easily to the underdeveloped - not just the barbarians, but all the tribes. **There is no debate** - only the **certain “cause”**. **Feminists, Children and women (on average - quotas) are too stupid to debate - they know and understand very little about the world and are unable and UNWILLING to articulate any complex thoughts. It upsets them - how ignorant they are - so they resort to violence and abuse.**

Winning the debate is NOW about killing the opposition - not debating the issue and learning.

Children think that only righteous causes (what they are taught at school) should be allowed a voice. They believe that it is **right** that money, power and state control what is written, discussed and held up as certain causes. Rich tyrants are to be adored and respected ‘Dear Leader’. There is no **search for truth** - only the righteous certain causes for mobs and tribes.

They don't understand why “Free Speech” is important - they are not taught that - they are taught the opposite - kill all dissent that deviates from the mob view - is what they are taught. “Solidarity” “The Mob, United, Will never be defeated” (The **passive aggressive chant** of the smug, violent virtue signaler. They proclaim “Kill all men” or “Black Lives Matter” to re-enforce groupthink, bigotry, hate and division.

Tribal Bigotry Destroys Other Nations

This is obvious too.

<https://www.dailymail.co.uk/news/article-10564463/Russian-politicians-voted-recognise-separatist-enclaves-speak-against-Ukraine-invasion.html>

“Vyacheslav Markhaev, a senator from Siberia, wrote on Facebook that Putin 'hid plans to unleash a full-scale war with our closest neighbour'. His remarks follow two of his party colleagues who have denounced the invasion.

Also see for context *Russia, Ukraine, and the West* | **Frederick Kagan** | *The JBP Podcast* | #230 568,237 views Feb 28, 2022 <https://www.youtube.com/watch?v=Ys2zTL-b3eE> “Who really Knows? (the truth) “ 53:30

Firstly we take the recent example of “buyer’s remorse” (**Silk** purse/sow’s ear) as we examine the thinking behind this and some other Russian Politicians. They voted to invade a nation based in the idea that two regions were suffering from genocide (presumably Russian people) from Ukrainian (tribal, racism, etc). i.e. Ukrainians were committing genocide (of some unnamed group) in their own country/nation. Russians were going into war to do “**Good**” they were told

*'Zarathustra was the **first** to see in the **struggle between good and evil** the **essential wheel** in the working of things' - Author(**Friedrich Wilhelm Nietzsche**) Year[1891] Source_Document(Thus Spake Zarathustra) Keyword(Humanism Choice Individual) <http://www.gutenberg.org/files/1998/1998-0.txt>*

Aside: Nietzsche’s book is dripping with mocking sarcasm and sardonic, derisive humour. We are asked to **question** whether he is joking or not. “*Tell the truth and aim straight*” - is that the true message or the joke that prophets always tell? We have to ask ourselves whether he really means what he writes or is just mocking the prophets or something else? Good and Evil are always wielded by the prophets - it is their remote control mechanism of the dim-wits, and prophets are always “THE FIRST”. So is it the **struggle between**? Or the **essential wheel** as a new insight for Nietzsche as the prophet? Is it the escape from binary thinking of Good and Evil? I cannot tell what he was thinking - I can only deal with the words he has written.

*'**The good--they have always been the beginning of the end**' - Author(**Friedrich Wilhelm Nietzsche**) Year[1891] Source_Document(Thus Spake Zarathustra) Keyword(Humanism Morals Group) <http://www.gutenberg.org/files/1998/1998-0.txt>*

*'The whole problem with the world is that **fools and fanatics are always so certain of themselves**, but wiser people so full of doubts. The fundamental cause of the trouble is that in the modern world the stupid are cocksure while the intelligent are full of doubt' - Author(**Bertrand Russell**) Year[1933] Source_Document(The Triumph Of Stupidity) Keyword(Humanism Certainty Group) <http://russell-j.com/0583TS.HTM> <https://quoteinvestigator.com/2015/03/04/self-doubt/>*

*'A Good Theory is one which **can be tested** to be false' - Author(**Karl Popper**) Year[1920?] Source_Document(paraphrase) Keyword(Humanism Science Individual) https://en.wikipedia.org/wiki/Karl_Popper <https://en.wikipedia.org/wiki/Falsifiability>*

*'**The road to hell is paved with good intentions**' - Author(**Bernard of Clairvaux**) Year[1153?] Keyword(Humanism Choice Group) https://en.wikipedia.org/wiki/The_road_to_hell_is_paved_with_good_intentions https://en.wikipedia.org/wiki/Bernard_of_Clairvaux see my Map for his travels https://www.google.com/maps/d/viewer?mid=1dlqz_4B5_uqCAHD4SoJKGaPqRW69WByi&ll=3.81666561775622e-14%2C4.263256414560601e-14&z=1*

*'The ideals which have lighted me on my way and time after time given me new courage to face life cheerfully, have been **Truth, Goodness, and Beauty**' - Author(**Albert Einstein**) Year[1931] Source_Document(Excerpt from an essay originally published in “Forum and Century,” vol. 84, pp. 193-*

194, the thirteenth in the Forum series, Living Philosophies. It is also included in Living Philosophies (pp. 3-7), New York: Simon Schuster, 1931.) Keyword(Humanism Motivation Group)

<https://archive.org/details/TheWorldAsISeeltByAlbertEinstein> <https://genius.com/Albert-einstein-the-world-as-i-see-it-annotated>

'In the meantime, in Britain, there was some respite from foreign, but not from civil war. The cities destroyed by the enemy and abandoned remained in ruins; and the **natives, who had escaped the enemy, now fought against each other**. Nevertheless, the kings, priests, private men, and the nobility, **still remembering the late calamities and slaughters, in some measure kept within bounds**; but when these died, and **another generation succeeded, which knew nothing of those times**, and was only acquainted with the existing peaceable state of things, all [pg 042] the **bonds of truth and justice were so entirely broken, that there was not only no trace of them remaining**, but only **very few persons seemed to retain any memory of them at all**. To other crimes beyond description, which their own historian, Gildas,¹⁰³ mournfully relates, they added this—that they never preached the faith to the Saxons, or English, who dwelt amongst them. Nevertheless, the goodness of God did not forsake his people, whom he foreknew, but sent to the aforesaid nation much more worthy heralds of the truth, to bring it to the faith.' - Author(**Bede The Venerable**) Year[731] Source_Document(**Bede's Ecclesiastical History of England**) Keyword(Humanism Corruption Group)

<http://www.gutenberg.org/files/38326/38326-h/38326-h.html#toc41>

So rather than make this an case for an international court and some **due process** - the Russians decided (Rush to judgement/vigilantism/mob action) and agreed that invasion of country or a region of country to “liberate” it was “good” idea and entirely rational and reasonable - even from someone who hates war and knows about it’s consequences. This was known to those in power - they all agreed but they **told the Troops that it was only exercises**, then it was only a **small rescue mission of designated victims** - not a full on war.

It always starts as a heroic rescue mission of designated victims

So let us first deal with the idea of invasion instead of defense.

Defending a country is **different to invading** or **destroying** a country. Going to war to defend a NATION is different to joining the Islamic causes to invade other countries and DESTROY NATIONS. Get it yet?

See Meta Frame **10. Proportion** <https://humanistman.com/wp-content/uploads/2019/03/08-Humanism-Meta-Frames-Proportion.pdf> (Fairness and proportional responses) and Humanist Frame **04 Humanism – Information Classification Frame, Version 1, date 10/02/2019** <https://humanistman.com/wp-content/uploads/2019/02/04-Humanism-%E2%80%93-Information-Classification-Frame.pdf> (choices and war between tribes)

Nations and **national boundaries** have some meaning - it is **one of** humanities attempts to overcome the **problems of tribalism**. This technique is only a few hundred years old and comes about after thousands of years of warfare (tribes, city states) in Europe where the populations had inhabited the whole geographical area. They had to learn to cooperate and not live as tribes. This is a **continuum and extreme problem** as well - we don't want the whole world to be ONE nation like some of the binary certain extreme social justice warriors (feminists, communists, socialists (United Nations) and other binary extremists - Chinese and other megalomaniacs) want. Plurality.

Some will argue the inevitability of war - that it is a natural human process for implementing change. Genghis Khan liked war, murder and destruction - as did all the other Barbarians. (*"They all do it"*)

Yet something balanced and movable on number and size of nations seems to have (hypothesis) value, interest and variability which have some "sufficient" "utility" (*as yet humanity has not a goal*).

'Humanism - the goal of maximizing human flourishing — life, health, happiness, freedom, knowledge, love, richness of experience' - Author(**Stephen Pinker**) Year[2018] Source_Document(Enlightenment Now: The Case for Reason, Science, Humanism, and Progress) Keyword(Humanism Development Individual) <https://stevenpinker.com/>

'As yet humanity hath not a goal' - Author(**Friedrich Wilhelm Nietzsche**) Year[1891] Source_Document(Thus Spake Zarathustra) Keyword(Humanism Choice Individual) <http://www.gutenberg.org/files/1998/1998-0.txt>

Let us note the Russian politician's use of the concept of **"The West"**. He sees himself (and China) as "The East" and the West as one group. So he is a **binary thinker** like the feminists, black movements, religious extremists, etc - "Us" and "Them". Who is **the West** exactly? Is it the **certain devil**? This is what China and Russia re-enforce with school, media and laws every day - "The West" - the corrupt enemy and "Us" - the righteous, all knowing, great example of humanity. Binary groupthink. Feminists, communists, fascists, socialists, religious zealots, women on average (Quotas) and weak minded men. Underdeveloped hate filled violent humans.

Don't underestimate those who think that they are the **"better"** humans - their **violence becomes unbounded** the more smug and superior they get. See Andrew Barr, Andrew Leigh, Penny Wong, Feminists, Labour, Greens, Magistrates, Politicians, Elites, media, etc.

Don't attack my **certain virtue**.

Note too that the “media” has some role in determining the “Truth” in his case the Russian media tells the “Truth” and the “West” lies. This is similar to how the ABC sees itself and other media empires - they see themselves as “Truth” and “Cause” propagandists rather than balanced or investigative journalists giving weight to many sides of complex debates. They tell the “certain Truth” - for the Cause - Humanity, the “Public Interest”, justice, Social Justice, Diversity, Equality, Feminism, racism, etc - insert your choice of binary mob like causes here.

*“the principle of distributive justice, once introduced, would not be fulfilled until the whole of society was organized in accordance with it. **This would produce a kind of society which in all essential respects would be the opposite of a free society**”.* Friedrich Hayek *“the Mirage of Social justice”*-
https://en.wikipedia.org/wiki/Friedrich_Hayek

Heyek argues against the binary extreme certain cause. But yet here we are with 60% of the public service made up of women promoted ahead of better qualified men based on identity, groupthink, nepotism and gender bias. Identity based quotes in politics, universities, boards, schools, public service, courts, etc. And it still goes on - **they refuse to stop the bigotry, nepotism and bias**. “We are the constant victims here” - says Penny Wong and the Labour party feminists.

See **What Were You Thinking** <https://humanistman.com/wp-content/uploads/2021/07/What-Were-You-Thinking.pdf>

So because everyone lies - who then needs any independent media and reporting??? Who needs debate?

See **Debates - Human Difficulties** <https://humanistman.com/wp-content/uploads/2019/10/Debates-Human-Difficulties.pdf>

<https://www.jewishvirtuallibrary.org/joseph-goebbels-on-the-quot-big-lie-quot> *“If you tell a lie big enough and keep repeating it, people will eventually come to believe it. The lie can be maintained only for such time as the State can shield the people from the political, economic and/or military consequences of the lie. It thus becomes vitally important for the State to use all of its powers to repress dissent, for the truth is the mortal enemy of the lie, and thus by extension, the **truth is the greatest enemy of the State.**”*

*This is an excellent definition of the “Big lie,” however, there seems to be **no evidence that it was used by Nazi propaganda chief Joseph Goebbels, though it is often attributed to him.***

*The original description of the big lie appeared in Mein Kampf. Adolf Hitler applied it to the behavior of Jews rather than as a tactic he advocated. Specifically, he accused Viennese Jews of trying to discredit the Germans’ activities during World War I. Hitler wrote of the Jews’ **“unqualified capacity for falsehood”** and **“that in the big lie there is always a certain force of credibility; because the broad masses of a nation are always more easily corrupted in the deeper strata of their emotional nature than consciously or voluntarily; and thus in the primitive simplicity of their minds they more readily fall victims to the big lie than the small lie, since they themselves often tell small lies in little matters***

but would be ashamed to resort to large-scale falsehoods. It would never come into their heads to fabricate colossal untruths, and they would not believe that others could have the impudence to distort the truth so infamously. Even though the facts which prove this to be so may be brought clearly to their minds, they will still doubt and waver and will continue to think that there may be some other explanation.... From time immemorial, however, the Jews have known better than any others how falsehood and calumny can be exploited."

The OSS psychological profile of Hitler described his use of the big lie:

His primary rules were: never allow the public to cool off; never admit a fault or wrong; never concede that there may be some good in your enemy; never leave room for alternatives; never accept blame; concentrate on one enemy at a time and blame him for everything that goes wrong; people will believe a big lie sooner than a little one; and if you repeat it frequently enough people will sooner or later believe it."

Hitler is observing the world he sees around him. **But how outrageous to suggest** that JEWS LIE - that is almost as bad as suggesting that WOMEN LIE or BLACKS LIE isn't it? Is groupthink Bad or not? We are all tribes aren't we?? That's **RIGHT, isn't it** - tribal views of the world? (see plurality which I discuss in **Gender** <https://humanistman.com/wp-content/uploads/2021/06/Gender.pdf>)

For some history of the Jew tribes examine the Knights Templar https://en.wikipedia.org/wiki/Knights_Templar, https://en.wikipedia.org/wiki/Teutonic_Order , history of the Jew tribes and cabals in finance in Europe (especially Austria) https://en.wikipedia.org/wiki/History_of_the_Jews_in_Austria - financing leaders and wars <https://www.habsburger.net/en/chapter/involuntary-loans-jews-financial-backers> and

The Origins Of Totalitarianism - Document[1958] Rank(10) Author(**Hannah Arendt**) Age(52)
Keyword(Individual Philosophy Politics)
<https://archive.org/details/TheOriginsOfTotalitarianism/page/n6>
https://en.wikipedia.org/wiki/The_Origins_of_Totalitarianism
<http://www.openculture.com/2014/02/hannah-arendt-archives.html>

There was plenty of money to be grafted/granted by keeping people SAFE on their journey towards holy lands of certainty. (graft (Written - proscribed - dogmatized) and corruption)

So the ABC tells big lies - that it is fair and balanced and not biased or corrupt. It will not answer my questions or report my story or it's own corruption. It lies (omits to tell the whole truth - hides things - Emphasis and Omission continuum) to the Senate, Ministers and to the public on a regular basis. This general DELUSION is shared by media companies in many places - some working for the state and others for business. Behind all of that is Virtue signaling, groupthink (Mobs, tribes) and BINARY extreme thinking that we see at all levels of public life. **Some is plain Bad acting** and **corruption for personal gain** - this is becoming more widespread now - *the way we do things around here*. The Russian Oligarchs are not so different to the Chinese, Canadian, Australian Elites and Feminists operating as Oligarchies around many corrupted nations.

If I become incoherent all I need to do is display my virtue and stoke empathy and mob reaction.

It does not matter how much I lie (everyone does it, no-one is perfect, it is the way we do things around here) - so who needs Truth or debate when you have a great cause of binary certainty and a Drama Triangle with Heroes, Victims and Perpetrators? - All the while the profiteers - the Legal class, accountants, bankers, elites, etc - all claim moral superiority (Positioning game) over the "Corrupt" Bad actors they serve (See Swiss banks, Tax havens, Superfund Managers, Tax Free "Charities" run by the Elite, etc)

See **Corruption - Extremists** <https://humanistman.com/wp-content/uploads/2020/01/Corruption-Extremists-Feedback.pdf> - especially positioning and biases.

Could it be that feminists, BLM , Socialists, Communists, and other extremists are running the propaganda straight out of Hitler's playbook?? George Orwell's written warnings become another playbook on manipulation for use by the Feminists, binary extremists and other corrupt bad actors of society?

Who needs to **LEARN** Truth when you can fill your virtue Cup by blaming others and joining in **POPULAR** mob violence against the "perpetrators" (white men - the "others") ?

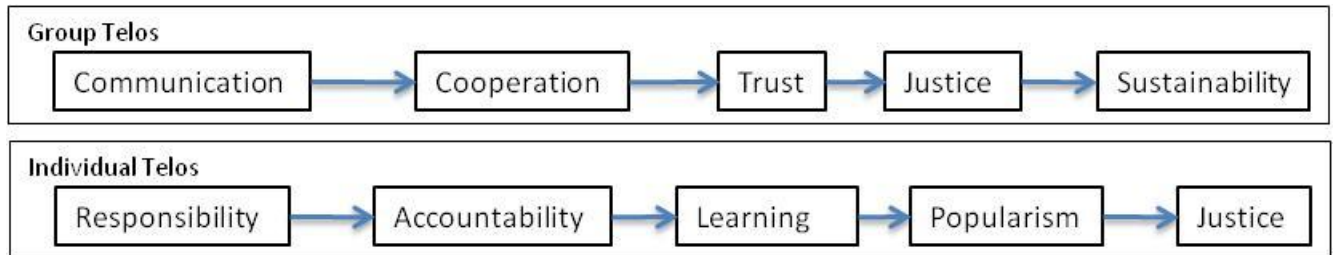

Responsibility, Accountability, Learning - all disappear when the CAUSE IS GREAT.

Communication, Cooperation, Trust are not required when the CAUSE becomes **JUSTICE** itself. *Let us rush to justice before we think or do anything else.* Women are victims, Kill all men, Black Lives matter - insert your pig-ignorant, binary, group think, bigoted, identity, hate filled cause here. It is our habit.

Tribes and Tribal warfare dominate the planet.

The Chinese Tribe see themselves as **special entitled humans** based on slanty eyes, skin colour and about 25 books which represent their **entire thinking**. "Confucius Institutes" (the great "Wisdom of 2500 years ago - the special "books" of certain dogma). Bigoted Racism and **entrenched tribalism** and pig-ignorance. The Chinese smug certainty comes from **what they see** as being "Non-religious" or "above religion" - so their cultural zealotry (Confucius/Tao, etc) they think is different to other dogmatic religions - in a certain special way. **"Our certain Dogma is SPECIAL"** - say the pig-ignorant binary extremists.

The “West” is the certain devil to the Chinese tribe and is broadcast daily from their “Right Thinking” media for “the cause”. They also run the Entitled/Victim narrative we see from Feminists, Communist, Religious Zealots, Russians and other binary extremists groups. Hence national boundaries mean nothing to the bigoted, racial, hate-filled Chinese - they are the entitled Humans - they are the Real Humans - the latest TYRANNICAL DICTATOR FOR LIFE - is pushing as many CERTAIN RED BUTTONS worthy of any pig-ignorant human scum.

The Smuglifunt - the specially entitled Human - see Labour, Greens, the ABC, Magistrates in A.C.T., Feminists, etc - fill themselves with smarmy smugness and violently attack anyone who threatens their cave of certainty. Questions must be destroyed. They double down on their violence like all tribes do. See the Australian Senate, feminists, women (on average - quotas, wages isn't about time we had a women god?) everywhere (instant smug outrage and violence).

Black nomadic tribes roam the planet claiming to be “Nations” - fighting over boundaries, resources and virtue signaling superiority.

Concepts of Equality, “Equity”, Diversity, Inclusion and Nation - all defined by Feminists, Tyrannical dictators and other deluded binary psychopaths as Bad Actors intent on corrupting and destroying humanity.

The tribal narrative - especially by women, blacks, jews, greens, Chinese, Russians, etc - is designed to divide societies and promote violence, looting, pillaging and profiteering from the attack on others. We see this all over the world but also it goes back in history. There were **MANY enlightened rulers of city states in the past** but there were also ruthless dictators and tyrants - like the politicians we see in Australia and around the world now. Liars, bullshitters, deceivers, abusers, etc - usually supported by easily framed virtue signalers or bad actors (media, legal class, elites, feminists extremists, binaries, **profiteers**, etc) - **all out destruction** (“*lets burn this place down*” - ABC women say) and change everything they choose in a Genghis Khan kind of owning the world way. An underdeveloped human with baby tantrum like behaviours and determined pig-ignorance of the world.

The tribal invasions of Ukraine by Russia are based on the idea that Russian tribes people who live in other nations have to be “protected” - read **INVADED** by the nation Russia when it declares that it's “Citizens” (tribe) are not being treated well. Hence all out war against other nations is justified based on a race declaration - **institutionalized racism**. We see this racism in Australia and other countries as Feminism, The Office of Women, Black lives matter, a “Voice to parliament”, “Truth telling” - but also too as the Tax arrangement for American (USA) citizens when they are living in other countries - Americans still have to pay tax to the “Mother country”.

China is a fully racist country which sees itself as the cradle of civilization - in this way it can view everyone else as less than human and thus able to be abused at the pleasure of the Chinese. Most citizens in China believe this (70%+) in the same way that most citizens in Russia support the current dictator there and his violence and abuse of others - other tribes - for the benefit of their own tribe. We see this in feminists - of course - but also too in the binary religious zealots throughout history.

China does not believe in nations - it believes China's race of people are entitled to the whole world. Again this echoes feminism of course - this entitled/victim narrative - but with China - they are tending to channel the morals and thinking of Genghis Khan. Their *enlightenment* comes when they take the non-Chinese people in their nation and reeducate them and inter them into concentration camps - abusing them and treating them in a less than human way. See how "enlightened we are?"

The Chinese believe that - while they are entitled to kill and murder people at whim (Remember the rape of Nanking (Japanese soldiers playfully dismembering Chinese coolies based on racial de-humanization)) - that they are "enlightened" in a Confucius (Kong) kind of way because they only lock them up and hide people away from society rather than murder them straight away - they are **relatively "merciful"** to those poor less than human types then they come across. Think of Ming the "Merciful". They make good use of harvesting their body parts before they die as part of the "greater good".

See how well we position ourselves?

You will see this kind of convoluted thinking with Australia premiers and other tyrants when they say - *"look I reduced another "Mandate" - everyone should be grateful to your illustrious "dear leader"."*

The Chinese have already told countries that they will invade their country if Chinese people are "mis treated" in their country. i.e. a pre-emptive declaration of war on any nation were "RACIAL" Chinese - slanty- eyes - yellow skin - or whatever the Chinese tyrannical dictator declares means "Chinese".

This tribal bigotry - feminism, racism (blacks, etc) - is growing and brewing ever more world wide violence. Nations are being destroyed by tribal warfare and groupthink (Blacks, Women, Religion, Skin colour, etc).

Herbert Spencer had hopes for a low level of state control - "Statism" (another king of dogmatic groupthink and mob type action) that humans would somehow be able to effectively cooperate using market and other mechanisms - individuals would somehow work things out rather than groups.

Man versus the State - Document[1884] Rank(10) Author(**Herbert Spencer**) Age(64) Keyword(Individual Nation Thinkers Library) <https://oll.libertyfund.org/titles/spencer-the-man-versus-the-state-with-six-essays-on-government-society-and-freedom-lf-ed> <https://rationalist.org.uk/archives> <https://fee.org/articles/book-review-the-man-versus-the-state-by-herbert-spencer/> *"Chiefly, however, the maintenance of this faith is necessitated by the **maintenance of fitness for war**. This involves continuance of such **confidence in the ruling agency**, and such subordination to it, as may enable it to wield all the forces of the society on occasions of attack or defence; and there must survive **a political theory justifying the faith and the obedience**. While their sentiments and ideas are of kinds which perpetually endanger peace, it is requisite that men should have such belief in the authority of government as shall give it **adequate coercive power over them for war purposes—a belief in its authority which inevitably, at the same time, gives it coercive power over them for other purposes.**"*



Вячеслав Мархаев

27 February at 16:25 · 🌐



Dear friends,

It is sad to watch what is happening around Ukraine, and it hurts the soul, imagining where our world and the whole world's contribution can go...

First of all, I would like to note that we have ratified the recognition of the People's Republic of DPR and LPR. For 8 years, the world public has not noticed the genocide of the peoples of these regions, the western media has not noticed the lawlessness, the violation of the principles of democracy and human rights in general. The most unpleasant thing about this is that the leadership of Ukraine itself closed its eyes to this, putting false and distorted accents according to the Western decree. We needed the recognition of the independence of the Republic of DPR and LPR to protect them from complete extinction. It was thought that this could be developed the possibility of continuing negotiations and finding new compromises to settle all sharp corners.

To my great regret, the whole Campaign in recognition of the DPR and the LPR had a completely different idea and plan, which was initially hidden, and as a result, we were in a state of full-scale confrontation and war between the two states. We did not have enough endurance, nor political will to try after recognition that the republics of DPR and LPR continue to gain their positions peacefully. Has "denacification" and "demilitarization" always been solved exclusively by military means?

I condemn any radical nationalist movement, I will not accept genocide, destruction and lawlessness. But just as much as I hate war and military solution of issues. I say this not as a foreign observer or a politician, but as a direct participant of such, very recent, events of Russian history. It is very painful to lose colleagues, colleagues, co-workers, ordinary young and promising guys. It is very painful to look in the eyes of their parents, children and loved ones.

I condemn the West's unjustified strategy, their double standards policies, promoting their own interests through a change of lawful power in countries they don't suit, seize new territories under false slogans of protecting democracy. I also condemn the leadership of Russia, which began to use the same methods of double standards. Under the aegis of recognition of the DPR and LPR, we have hidden plans to launch a full-scale war with our closest neighbor.

Today there is a war between two friendly nations, whose leadership was not enough, unfortunately, neither the mind nor the will to avoid the confrontation. So this is also our fault. We couldn't find the right words, we couldn't find a right solution. In this case, I mean a fact like the events of 2014, when it could still be resolved peacefully. It is sad to admit that today all wars on the Planet are lobbied not by the interests of peoples, but by the interests of business elites within states. We are watching a crisis of world order and order.

Given the current situation and the emerging situation between Russia and Ukraine, I am convinced that the development of the confrontation becomes at the hand of the third parties. To whom this war is most profitable?! I am convinced that neither the people of Russia nor the people of Ukraine need such a war... Every nation, every nation should have the right to self-determination, to the freedom of their choice...

Sacrificing Expensive Chickens For Things Not Understood

Sacrificing children to stop earthquakes and maintain the High priests of certainty is a human pattern. The Delusional excuses for the constant failure has turned into an art form we see all the “predictors” and “experts” use for their tyrannical, abusive “FINAL SOLUTIONS”. Large and expensive computer models (as big as Douglass Adams planet) predict the certain world in a GOD like way for the dim-witted mobs (70% of the population) - Feminists and other binary extremists, women (on average - quotas, average wages) and weak minded men.

Give me all of your money and I will preach certainty for you.

The certain answer is not 42 - is it a planet of humans and other things just like ours in **an experiment** run by white mice as revenge? (Douglas Adams)

Don't' just do Something, Stand There!

The Nation Experiment

Binary tribalism became **cooperation** in more complex binary support arrangements. Pairs of relationships between tribes became complex hierarchies of binary engagement. Friend or Foe. Neutrality became a third option. Nothing, Null. Then trade routes opened up and cities accommodated travelers from all tribes. Coastal (Levant) and river (Egypt) first but then places like **Merv/Margiana/Merve Oasis/Alexandria/Antiochia** in Margiana/Marw al-Sh-ühij-ün - Ancient_City[-3000 to 1790] and **Buhe/Puhe/Bokhara/Bukhara** - Historic_City[-3000 to 2021] - along the silk road and having to maintain strong settlements while coexisting with different roaming nomadic tribes. Later came Babylon, Troy, Turkey, Carthage, Rome.

Long periods of enlightened rulers who could communicate, debate and discuss - working from principles and mutual benefit but also not trying to damage each other - not binary certain -

“I promise not to wipe you out but I will not always support you” - Eukaryote(Dan Dennett)

Concepts of Cooperation, Trust, Justice and Sustainability grew. The Debate began.

Sometimes **marriages** helped strengthen tribal relationships, sometimes **hostages** or **prisoners of war** (see **Guantanamo Bay** on how USA and it's allies operates https://en.wikipedia.org/wiki/Guantanamo_Bay_detention_camp) were kept as insurance against bad behaviour. This sometimes resulted in dire consequences depending on how badly you treated your hostages. Simple Vlad became the Vlad the impaler - for example.

Vlad the Impaler/Vlad Dracula Dracula - Lifespan[1428 to 1476] Born_Loc(Sighișoara) Rank(80) Keyword(Politics, King) https://en.wikipedia.org/wiki/Vlad_the_Impaler <https://www.smithsonianmag.com/smart-news/archaeologists-think-theyve-found-dungeon-where-dracula-was-kept-180952913/>

See **Tokat/Comana Pontica/Evdokia/Eudoxia/Dazimon** - Historic_City[-3000 to 2022] 40.32346, 36.55219 on my map https://www.google.com/maps/d/viewer?mid=1dlgz_4B5_uqCAHD4SoJKGaPgRW69WByi

The tribes and binary thinkers grew in number and the relatively few who remained free of binary tribalism and hatred faced a constant challenge of overcoming the mob violence - but changes did take place and humans started to consciously debate, value and appreciate things rather than just react or sacrifice chickens to their ignorance. Libraries of written words grew and these became a vast store of knowledge and information to be used for discussion and debate. Messages were left by those who became before us. Messages were stored in libraries and some were stored in jars in caves and buried to be kept safe from the plunderers. Those who knew things made sure the messages were passed on from generation to generation.

City states formed alliances - empires grew and changed format from geographic boundaries to boundaries in the **mind of beliefs (constrained and bounded)** - empires within empires - more complex wars **about ideas of certain utopia** not about food to eat any more, but also still about baubles, bangles, beads, trinkets, treasure and shiny things. There was enough food most of the time because of shared learning and trade so humans invented other ways to fight each other. Books of **learning, messages and advice** were **taken by the ignorant** and turned into books of **binary certain dogma**.

Being human became devalued. **Being “Special” became everything**. The fight for “special” rather than the appreciation of “individual”.

Differences became highlighted - as a race to **certain specialness**.

The **world stage grew in size** so the **deluded narcissistic psychopaths** could affect more people. United Nations, Wars, Celebrity idiots, Princesses, “World Forums”, etc.

The **Tribes changed shape** from simple locations or roaming nomadic groups - to tribes of skin colour, language, gender, clothes, history, beliefs - **anything to remain tribal** and operating anywhere in the world - any country any time and place. Nations were under constant attack from the tribes.

Trust is Destroyed

Creeping Totalitarianism and Dogma as implemented by all the public service, politicians, courts, legal profession, businesses, etc is destroying trust. Privacy does not matter any more - no one is free to do anything. Cameras monitor you all the time, internet and phone calls are routinely logged and stored in databases for use by various agencies tasked with “keeping you safe” - we have data sharing arrangements with other countries and it is growing as idiot zealots herald a “new age” of data matching across the world.

Extract from a data warehousing job sent to me with KPMG:

- Are you **passionate** about Digital Transformation?
- Do you **embrace digital disruption**?
- Are you **convinced** that the **Fourth Industrial Revolution** is fundamentally changing the way we live, work and relate to each other?
- Do you aspire to create the **best customer experiences** across Mobile App & Web, and User Experience (UX) & User Interface (UI)?
- Do you **believe** in creating **powerful actionable insights from Data and Analytics**?

You are tracked monitored all the time by government and private enterprise. Your mobile phone is for **their use** - not your convenience. Your email address is for politicians to ask for money and feed you their messages, for business to spam you every day - their convenience - their purpose - their control.

Public servants sit around and devise new ways to limit your privacy and monitor the population. They want to ensure everyone is complying with their dogma - their laws, by-laws and regulations. Lawyers and binaries love this kind of personal intrusion. Judgement and demonization is constant. Far from mandating vaccines - you are not allowed to get your prescriptions for medicine filled in advance - you have to prove you are going overseas or away otherwise Chemists will refuse to fill you prescription - you are considered a potential criminal if you dare to fill your prescriptions too early for the dogma. This is the opposite of Mandating but it is coercive CONTROLLING THROUGH DOGMATIC CERTAINTY and prove yourself innocent type thinking. Everyone is a judge and a spy ready to Dob You In.

Your garbage is emptied by a truck which has a camera mounted on it. They inspect your garbage using the camera and monitor what you are throwing out. They contact you if you put the wrong type of rubbish in the garbage - your social credit system is already in place. A friendly reminder turns into mandated crimes against humanity.

Your tyres will be slashed by activists if it is deemed you drive the wrong type of car - See ***Climate-vandals are coming to let down your SUV tyres — if only they had evidence to persuade you instead*** (March 21st, 2022) <https://joannenova.com.au/> . London has already Banned (Mandated) certain types of car from the city - Erin Pizzey had to change her car - buy a new one - so she could continue to get around London. Bettina Arndt, myself and many others donated money to help her buy this new MANDATED CAR <https://www.gofundme.com/f/help-erin-back-on-the-road> .

The smuglifunts fill themselves with virtue as they do everything to mandate **their certain good on the rest of humanity.**

Violence is no problem when you are fighting for the “cause”

Tyrants have to mandate everyone’s “cooperation” for the cause - take the knee, virtue signal, coercion, control, shame, blame.

Everyone becomes a “little hitler” when the laws give them some power and control - they cannot wait to exert their “grand plans” and certain idiotologies.

You cannot join a club or ask for a service, buy food, use cash, or engage into a simple transaction with the agency wanting to have your name, date of birth, bank details (credit cards for everyone), health status, address and phone numbers so they can use the details for their “convenience”. ***Swipe your full identity card - put your photo on it so we can give it to the police - see how convenient it is?***

They ring you on the phone when they feel like - at their convenience - they enter your home when they feel like it - police turn up to arrest you if you post anything on the internet or send email messages or letters to anyone they deem unacceptable.

You cannot join a club without showing your papers and having photo id - **just in case (female anxiety and hysteria)** you commit a crime. Everyone (males) is potential criminal so they must enter with all restrictions in place - microchips, masks, ids, passports, tests, red tape and a constant intrusion and **lack of trust** in any human - all potential villains, virus spreaders, murderers, rapists, etc - men of course are

assumed guilty of everything all the time - not only in courts (domestic violence “laws”, family courts) by schools, universities, etc.

See **Corruption - Binary Thinking - Prove You are Not A Criminal** <https://humanistman.com/wp-content/uploads/2020/07/Corruption-Binary-Thinking-Prove-You-are-Not-A-Criminal.pdf>

Young people running businesses simply have no understanding of the simple ideas of Cash Money. Using a hard currency to buy things from businesses. They have no concept of legal tender and why it is important. *Surely everyone has a bank account, credit card and mobile phone* - they say. Tell that to the homeless man in the street trying to buy food to stay alive. *Surely everyone has a medicare card - surely everyone has a bank account, surely everyone has enough money to buy an electric car.*

If you remove the opportunities to trust people then people will forget how to trust anyone. This is a **vicious cycle**. It is a feedback loop.

Trust **NEEDS TO BE** practiced. Parents know this.

Vienna has an honor system on public transport - **Trust is practiced on a daily basis** <https://www.visitingvienna.com/transport/public/> - as well as pride, respect, appreciation and gratitude - that they have a good system which works well and people are trusted. **The community benefits from displays of trust.**

Tyrants, Dictators, Feminists, Binary Extremists, Women (on average - believe all women, women are victims) and weak minded men do not understand this - Trust means nothing to them.

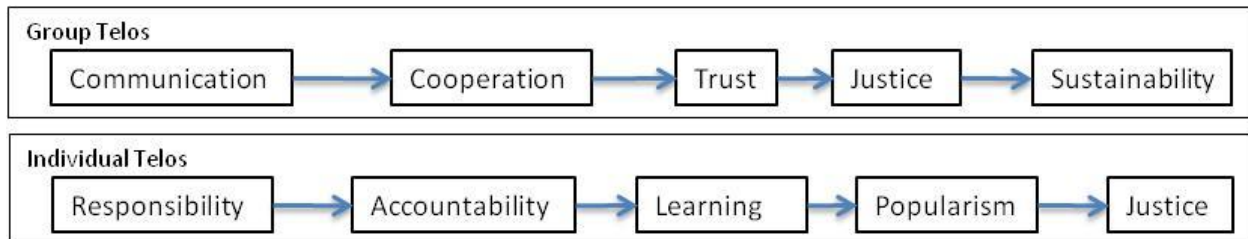

Mistakes will and MUST be made by individuals BUT the GOVERNMENT MUST NOT IMMEDIATELY JUMP ON PEOPLE WHO MAKE MISTAKES

How else can you learn?

Tyrannical Dictators Psychopaths Extremists

When you see Chinese, Korean and Russian leaders declaring themselves dictators for life (and the life of their family) - **when you see** them repress debate and silence opposition (Sometimes with poison and assassinations - not just in the media and public life (social credit systems - access to finance, goods and

services) or locking up humans secretly in Canberra jail cells - but the actual taking of life) - **when you see** them deny reality and manufacture wholly false narratives, control the media, education and universities, banning books and people from speaking - are you reminded of anyone in your own environment????

Does it look familiar to you?

Do you notice how people refuse to give up power - no matter how many times the voters criticize them. Do you notice how they say things like *"It is just that the voters do not understand me - they did not get our message properly - they don't understand how good we really are and how bad the others (the alternative - the enemy) are - " we are "better" than the other binary choice. (race to the bottom)*

Do you notice how much they **love themselves** (narcissists) and seem to **lack any authentic humility** or **potential to learn and develop**?

Do you notice how they **corrupt the political system** - removing checks and balances, appointing their own judges, increasing their own wealth and power, exempting themselves from the laws they make for other people to follow? (Privacy/Superannuation/criminal and other laws) Full of pretence and lies they ask you to go along with their delusion - to share their delusion? **Have you noticed?**

Do you notice how they call you "the west" or "the others" or "misogynist" or "racist" or "transphobic" - when any question is raised - or you dare to oppose their incoherence, hypocrisy, lies and tyrannical authoritarianism?

Do you notice the passive aggression - the **entitled victim/virtuous hero narrative**?

Do you notice the **violence and abuse** which follows from the passive aggressive entitled victim narrative?

Do you notice the **corruption** - the nepotism and the sycophants (the elites) who profit from the lies and corruption?

Do you notice the division into mobs and groups and the deliberate constant fear, hate and groupthink broadcast on a daily basis - the constant propaganda? (1984,ABC,SBS,etc)

Do you notice the avoidance of debate, the **rush to judgement** followed by an "ends justifies the means" mentality (Lord Acton - power corrupts) usually followed by violence and **smug self-satisfaction?** - smuglifuntism

Do you notice how often **"the greater certain good"** destroys large numbers of individuals who might disagree?

Do you notice how Hitler's behaviour seems familiar? *"His primary rules were: never allow the public to cool off; never admit a fault or wrong; never concede that there may be some good in your enemy; never leave room for alternatives; never accept blame; concentrate on one enemy at a time and blame*

him for everything that goes wrong; people will believe a big lie sooner than a little one; and if you repeat it frequently enough people will sooner or later believe it."

Are you noticing the politicians, elites, legal community, courts, feminists, media, women on average (quotas, etc), weak minded men (and other binary extremists), public service, schools, universities?

Do you notice the constant **one-sided** (binary/tribal) and narrow view of the world. Do you notice how corrupt our media, education and cultural systems are? Do you think every other tribe has their own version? Do you think the propaganda in our country is different to others? Or is it the "truth"?

Love Letter To America (Rank:30) :Author(**Yuri Bezmenov**/Thomas Schuman) :Year[1984] Age(45)
:Keyword(Group Nation Propaganda) <https://www.economicstvoodoo.com/wp-content/uploads/Yuri-Bezmenov-Love-Letter-To-America.pdf>
https://archive.org/stream/BezmenovLoveLetterToAmerica/YuriBezmenov-LoveLetterToAmerica_djvu.txt <https://www.youtube.com/watch?v=avblhMi9OWg>

Propaganda and Delusions were not invented by the Germans or the Russians or the Chinese, USA, UK, Africans, etc. It is a human condition problem.

Do you notice the **destruction of Education** to become a training ground for certain causers, bigots, outrage, groupthink, hatred, moral grandstanding and virtue signaling?

A Rush to Principle

As a stark contrast to a "**Rush to Judgement**" - **imagine** you had someone in your MOB your group or tribe who whenever the Mob got riled up and demanded certain action - this one person said "**Hold-on - wait a minute - let us think a bit** - *about the principles involved, can we learn anything new or have any of our principles, frames, schemas been undermined, ignored and have now become in-coherent because of this intended action? Have I missed something important?*"

Imagine waking around the countryside as a mob - firstly the mob would get angry and abuse the one person - he just keeps doing that all the time - why doesn't he just play "**follow the dear leader**" like everyone else? - he keeps asking questions and tries to get other people to ask their own questions (See Socrates) - the mob is angry ,especially as they had not learned to think, imagine or use abstraction - they would be confused, upset and angry - their feelings would rise up. Then - as the tribe numbers dwindled and the one person turned out to make better choices than the idiotologists and hotheads who rushed off into their choice of certain death - the tribe might allow group discussion and the one person might become two or more. More **discussion before action** takes place.

Then, **as a principle itself** (in a recursive kind of way) - the principle of **debate and discussion within the group about principles** - you know - like a kind of general technique - **becomes valued, understood and appreciated.**

But, sometimes, after the discussion, the first choice is made - so it **seems like the debate was a waste of time and resources** and people invent sayings like *“Strike while the iron is hot”* and others counter with *“Look before you leap”*. We end up doing what the *“dear leader”* says anyway *“Don’t upset the applecart”*. **Fat, Dumb and Lazy** humans start to avoid the debate - they don’t understand the debate itself or all of the issues involved and they become more and more **resentful.**

Then the mob might **regress** (one step forward - two steps backwards) and become more mob like as other mobs join the group and the mobs have to re-learn everything all-the time - because this was not a genetic inheritance - but a learned and **hard won behaviour** (Hypothesis testing - see **04 Humanism – Information Classification Frame, Version 1, date 10/02/2019** <https://humanistman.com/wp-content/uploads/2019/02/04-Humanism-%E2%80%93-Information-Classification-Frame.pdf>)

There would always be the problem with the binary, mob like thinkers, the hot heads and the underdeveloped - feminists, binary extremists, women (on average - think quotas, average wages), children and weak minded men. The **technique of thinking** would be attacked because of jealousy, resentment and sheer bloody mindedness or the corrupt - especially the “virtue signalers” (filling their own god like certain cups of special certainty) and bad actors.

Schools and books might help too - but then the weak minded - especially women - would demand that the schools become easier and more suited to their ignorance and they would take over the schools and throw out all principles (pals - get it? - Tish boom) - until once again the hard won principle of debate and discussion was lost.

This next section is what I wrote about the idiocy of the Melbourne Declaration - the formal destruction of the education system by the binary thinkers and virtue signalers in **Why Not A Humanist Manifesto** <https://humanistman.com/wp-content/uploads/2021/08/Why-Not-A-Humanist-Manifesto.pdf> (Page 7)

National Values - the **Melbourne Declaration** (Andrew Barr, Julia Gillard - how **proud they are** to declare their certainty!) - the dogmatically **certain cause** for the zealots - **Educational Goals** <https://www.schoolgovernance.net.au/news/what-does-the-2008-melbourne-declaration-look-like-in-2019> , *“Due to the **abstract nature of the Declaration’s goals**, it is somewhat difficult to quantify the progress made in the last ten years.” ..” Why Has the Melbourne Declaration Been Ineffective? .. a greater emphasis on **soft skills**, a strengthening of **critical thinking skills**, a re-think of the ways that teachers **assess student learning** in the classroom, closer attention to **the language we use** when talking about education.” ..” Furthermore, the Declaration has a strong focus on **creating intelligent, successful and driven individuals** “ (**BY THE CERTAIN CAUSE???!!!**) “who contribute to the wider Australian community.”*

http://www.curriculum.edu.au/verve/resources/national_declaration_on_the_educational_goals_for_young_australians.pdf “- **act with moral and ethical integrity** – – understand and **acknowledge the value of Indigenous cultures** and possess the knowledge, skills and understanding to contribute to, and

benefit from, **reconciliation between Indigenous and non-Indigenous Australians** – are committed to **national values** of democracy, **equity** and **justice**, and participate in ..” (not rule of law?) Everyone becomes a **smug vigilante** for “equity” and “justice” - “success” - “driven” - **No-one thinks** this is insane, dangerous or incoherent. No-one studies history - only feminist history.

Why not **educational goals** of learning to read, write and spell? Why not learn maths, history, geography, art, science, language, grammar, logic, debate? **Encourage learning** and exploration? Tolerance not as dogma? If you cannot ENJOY LIFE when you are a child, then **WHEN????**

So you can see that **EQUALITY** and **JUSTICE** become the **CERTAIN DOGMA/CAUSE** of the schools - not learning, enquiry, hypothesis and tolerance of ALL differences - **only TOLERANCE OF BLACKS** (“Indigenous”)

Asking questions and **tolerating** and **enjoying debate is to be encouraged and valued for how it helps to explore the human condition.**

'Who controls the past controls the future. Who controls the present controls the past.' - Author(**George Orwell**) Year[1949] Keyword(Truth Corruption Group) <http://gutenberg.net.au/ebooks01/0100021.txt>

'**Human plurality**, the basic condition of both action and speech, has the **twofold character** of equality and distinction. If men were not equal, they could neither understand each other and those who came before them nor plan for the future and foresee the needs of those who will come after them. If men were not dis- tinct, **each human being distinguished from any other who is, was, or will ever be**, they would need neither speech nor action to make themselves understood.' - Author(**Hannah Arendt**) Year[1958] Source_Document(**The Human Condition** Page 175) Keyword(Politics Communication Group) http://sduk.us/afterwork/arendt_the_human_condition.pdf
https://archive.org/details/ArendtHannahTheHumanCondition2nd1998_201703

'Teachers should **prepare the student for the student's future, not for the teacher's past.**' - Author(**Richard Wesley Hamming**) Year[1997] Source_Document(**The Art of Doing Science and Engineering**) Keyword(Development Teaching Individual) https://en.wikipedia.org/wiki/The_Art_of_Doing_Science_and_Engineering
<http://worrydream.com/refs/Hamming-TheArtOfDoingScienceAndEngineering.pdf>

'The **enemy of the moment** always represented absolute evil, and it followed that any past or future agreement with him was impossible. ... He, Winston Smith, knew that Oceania had been in alliance with Eurasia as short a time as four years ago. But where did that knowledge exist? ... It was quite simple. **All that was needed was an unending series of victories over your own memory.** “**Reality control,**” they called it; in Newspeak, “doublethink.”' - Author(**George Orwell**) Year[1949] Source_Document(**1984** page 43) Keyword(Humanism Extremist Group) <https://www.planetebook.com/free-ebooks/1984.pdf>
<https://www.george-orwell.org/1984>

The Genetical Theory Of Natural Selection - Document[1930] Rank(1) Author(**Ronald Aylmer Fisher**) Age(40) Keyword(Group Development Evolution)

<https://archive.org/details/geneticaltheoryo031631mbp/page/n12/mode/2up>

<https://www.genetics.org/content/154/4/1419> https://en.wikipedia.org/wiki/Fisher%27s_method

The Design of Experiments - Document[1935] Rank(10) Author(**Ronald Aylmer Fisher**) Age(45)

Keyword(Individual Science Maths) <https://archive.org/details/in.ernet.dli.2015.502684>

https://en.wikipedia.org/wiki/The_Design_of_Experiments <http://tankona.free.fr/fisher1935.pdf>

P Value and the Theory of Hypothesis Testing: An Explanation for New Researchers - Document[2010]

Rank(20) Author(**Ronald Aylmer Fisher**) Keyword(Group Hypothesis Choice)

<https://www.ncbi.nlm.nih.gov/pmc/articles/PMC2816758/>

<https://www.adelaide.edu.au/library/special/mss/fisher/>

Ressentiment - Document[1913] Rank(20) Author(**Max Scheler**) Age(39) Keyword(Group Nation Acting)

<https://hscif.org/wp-content/uploads/2018/04/Max-Scheler-Ressentiment.pdf>

<https://philpapers.org/rec/SCHR-22> [https://en.wikipedia.org/wiki/Ressentiment_\(Scheler\)](https://en.wikipedia.org/wiki/Ressentiment_(Scheler))

See <https://humanistman.com/home/articles/> **Why are some ideas so upsetting to some people**

<https://humanistman.com/wp-content/uploads/2019/01/Why-are-some-ideas-so-upsetting-to-people.rtf>

See **Observe – The Fool and The Expert** <https://humanistman.com/wp-content/uploads/2019/09/Observe-The-Fool-and-The-Expert.pdf>

See **Debates – Human Difficulties** <https://humanistman.com/wp-content/uploads/2019/10/Debates-Human-Difficulties.pdf>

See **15 Humanism – Corruption – Nation Choice – Virtue, Version 1, date 03/04/2020**

<https://humanistman.com/wp-content/uploads/2020/04/15-Humanism-Corruption-Nation-Choice-Virtue.pdf>

Example – Bad Actor Manipulates Virtue Signaler
Corruption – Aligned With Group Telos – Modified to show archetypes

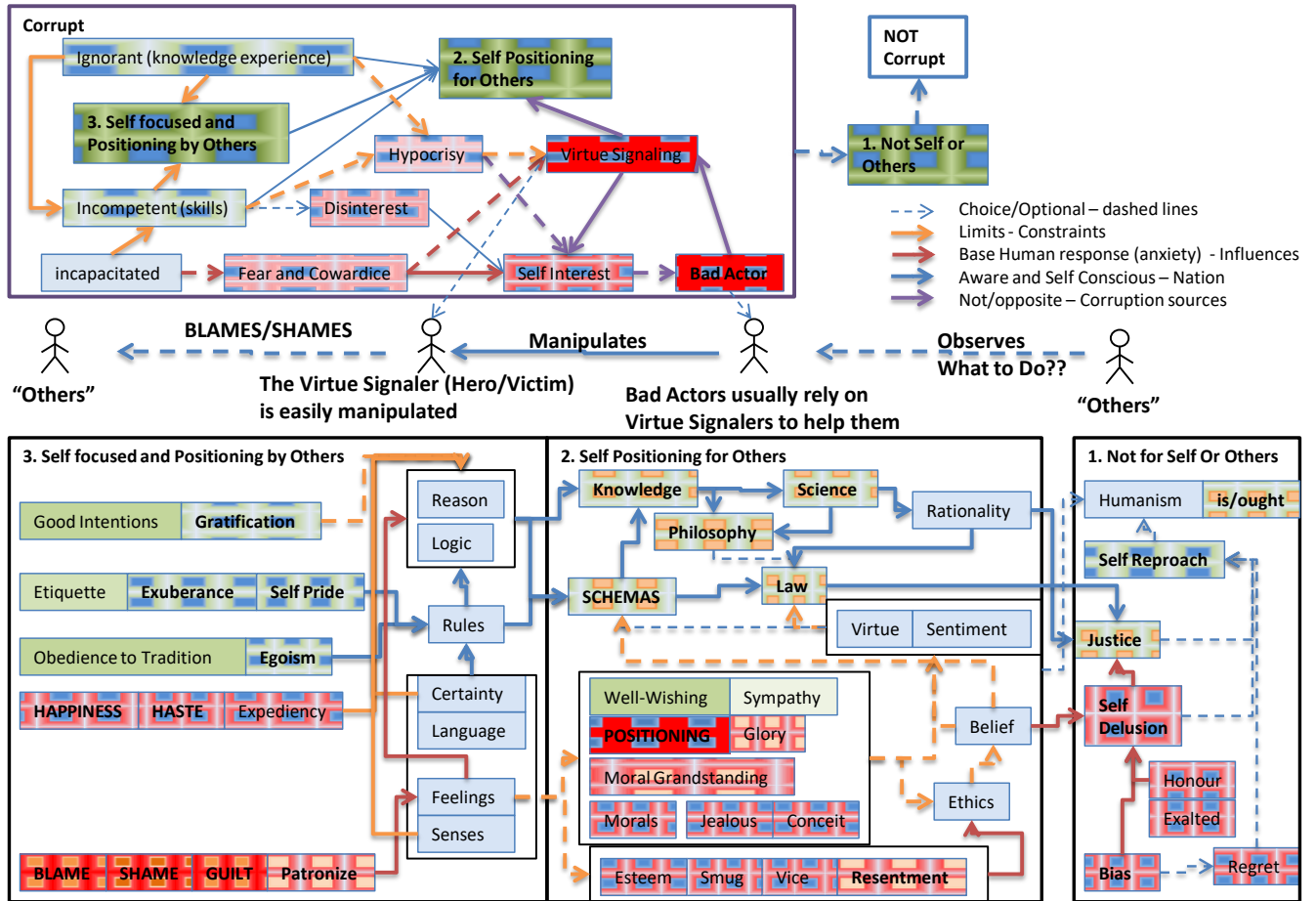

The Violence of the Smuglifunts

“I have undermined your claim that you have a valid claim on that position”, “Everything has become way more dangerous”, “This is not nothing”, “This invokes homicidal Ideation” - “A blunt form of re-establishment of something like competence” <https://www.youtube.com/watch?v=n9wzSpz7gKE&t=0s>
The Evolution of Desire | David Buss | The JBP Podcast | #235 157,610 views Mar 15, 2022 1:12 minutes in “We evolved all these mechanisms to keep the fear of death at bay” - **“Actual death is worse than the fear of death”**

The hypothesis and any Question fundamentally threaten the certainty of the binary view of self heroism.

Some humans will know how to do things better than you. Trust, Co-operation - we benefit from all of the best of us.

You might be incompetent in some things and driven by your special idiotology but you may be a good baker, driver, farmer, sewer, mechanic, flower arranger, artist, singer, etc. So while you might have little cognitive and intellectual capability and be threatened by things you do not understand - you still **have as much value as any other human** - especially in your ability to behave in a human way - to avoid **bad behaviour** - To seek a human value - regardless of your "intelligence", "money", "a big house" - you still have value - you are part of the human condition and you do not have to prove yourself by establishing superiority over other humans by killing them.

The human condition.

*Stop filling yourself with "Specialness" mate, you are human like the rest of us. "Get over yourself" you smug asshole" - **join the rest of us in the human condition - you elitist dickhead.***

Yes I am a Judge - "and a good judge too" (Gilbert and Sullivan)

Ungrateful Entitled Victims - Feminists

The mob is never satisfied - Aboriginal Flag - Amanda Stoker.

The cynical and blatant attempt to bribe the tribal mobs with gifts never works in the long run. It is a **never-ending blackmail/guilt/virtue trip**. *Say sorry, get on your knees to the cause, hand over more land, hand over more money, destroy your parliament and replace it with us, give us all the jobs, we will tell you if you have "reconciled" with us for your crimes, your actions, your skin colour, your parents actions, your tribes actions. How dare you think a "false flag" is enough - don't you realize how much of a victim our mobs is??? You should be outraged, guilty and ashamed at your cynical attempt to bribe us with beads - WE DEMAND EVERYTHING. How dare you!! Our **resentful revenge** has **no LIMITS**.*

The character and integrity of Amanda Stoker was on full display as she proudly declared how wonderful it was that the "black Flag" had been bought for 20 million dollars so that it's copyright restrictions were reduced so that all the blackfellas around the country could re-produce and use the flag (for their cause) and display it grandly as a nation flag. Australia has formally recognized the black flag as a "nation" flag of Australia i.e. we don't have a national flag - we have a **choice of which nation** you want to belong to Australia or Blackfella; or another way of looking at it would be that the **concept of nation does not exist** and the Australian flag is a TRIBAL flag like the blackfella flag is.

Every state and territory government and many government buildings and public spaces now proudly display the blackfella flag as equal or better than the Australian flag - some raising it above the Australian flag as some kind of virtuous display of GUILT on behalf of all people. *"I know I speak on behalf of all people when I say how sorry we are"*. Fuck-off idiot. They think this is a display of virtue and goodness for the "cause" - themselves and their virtue. Destroying the concept of Nation.

See **Racism and other Groupthink** <https://humanistman.com/wp-content/uploads/2019/08/Racism-and-other-Groupthink.pdf> and **Humanism Issue – Nation Law – Exceptions – Religion**

<https://humanistman.com/wp-content/uploads/2019/01/Humanism-Issue-Nation-Law-Exceptions-Religion.rtf>

Amanda Stoker could not and did not clearly articulate what she was thinking or why this decision was made. It was clearly a **virtue signal** and **bribe**. **This is what politics is now.**

So Amanda Stoker fails to grasp why her cynical and transparent bribe of virtue to the blackfella mobs was not treated with the glee and joy she had anticipated for her wonderful PUBLIC MONEY donation to the copyright owner of the "Aboriginal" flag so the tribal black mobs could **finally be "happy"**.

Amanda - blackfellas agenda is clear - like the feminists - total control and ownership of everything in Australia. This is their agenda and purpose. They declare it daily.

Stop giving it to them. You think you are being virtuous, "Moral", "Blessedness", "Better", "Righteous" - anticipating the "last judgement".

What were you thinking? What was going on in your mind? What Reason did you have? What hypothesis were you working on?

Grow a backbone. Take on the challenge of the Human Condition and stop wasting public money on your virtue.

Amanda is also deluded to think that her lies, hypocrisy and cynical bribes are opaque - that no-one can see them for what they are. It is like playing hide and seek with children and when the children hide - all they do is **shut their own eyes** because then they cannot see anything - they **assume no-one can see them**.

Why so hard on Amanda, Jon? Well I think Amanda **may have some potential** and I **hope** there are others who have potential to have the debate - overcome the tyrannical, smugliffuntism - the sneering, smarmy, virtue signaling, idiotologically driven Green and Labour types - that she is not a ghost, shade, performance piece, manipulative, passive aggressive, game playing, shadow puppet of her own virtue, soulless, inauthentic, greedy, self-centered (her own virtue), tantrum throwing, resentful, abusive lying **human**.

It is about time you started doing you fair share of the heavy lifting, humans.

Real humans are not marionettes with big wooden noses controlled by strings of smug certainty.

"Remember your humanity - forget the rest."

Jordan Peterson recently talks about that spark of life we see in babies and children - their authentic individuality and character - their "soul" - their humanity - we do not have better words for this **power and strength** of the human to be AN INDIVIDUAL and developing and taking their adult place in the world full of challenges and difficulties - escaping the cave and taking on chaos as best they can.

See works from:

Moral letters to Lucilius - Document[60] Rank(20) Author(**Lucius Annaeus Seneca**) Age(64)

Keyword(Group Development Humanism) https://en.wikiquote.org/wiki/Seneca_the_Younger
<https://plato.stanford.edu/entries/seneca/> <https://whatisstoicism.com/stoicism-resources/tao-seneca-free-pdf-downloads/>

Letter 37 On allegiance to Virtue *“Folly[4] is low, abject, mean, slavish, and exposed to many of the cruellest passions. These passions, which are heavy taskmasters, sometimes ruling by turns, and sometimes together, can be banished from you by wisdom, which is the only real freedom. There is but one path leading thither, and it is a straight path; you will not go astray. Proceed with steady step, and if you would have all things under your control, put yourself under the control of reason; if reason becomes your ruler, you will become ruler over many. You will **learn** from her what you should undertake, and how it should be done; you will not blunder into things. You can show me no man who knows how he began to crave that which he craves. He has not been led to that pass by forethought; he has been driven to it by impulse. Fortune attacks us as often as we attack Fortune. It is disgraceful, instead of proceeding ahead, to be carried along, and then suddenly, amid the whirlpool of events, to ask in a **dazed way**: “How did I get into this condition?” Farewell.”*

Letter 42 On Values *“Has that friend of yours already made you believe that he is a good man? And yet it is impossible in so short a time for one either to become good or be known as such.[1] Do you know what kind of man I now mean when I speak of “a good man”? I mean one of the second grade, like your friend. For one of the first class perhaps springs into existence, like the phoenix, only once in five hundred years. And it is not surprising, either, that greatness develops only at long intervals; Fortune often brings into being commonplace powers, which are born to please the mob; but she holds up for our approval that which is extraordinary by the very fact that she makes it rare”*

Why? There were hints - she was one of the few senators who realized her own behaviour when the senate abused Bettina Arndt for daring to ask a question.

Feminists now run most schools, universities, public services, courts, politics and media organizations,

60% of the public service is now women - hired based on being a woman or quotas - better qualified men are discriminated against legally using the legislation. “But there is still more work to be done” - there is no end to the corruption by the feminists in everything, - education, law, courts, politics, media, charities - everywhere there is a woman promoted based on identity.

Because 70% of everything is not enough - feminists have invented “inclusion” so that 80% inclusion is really, really good.

Women, Blackfellas are **trained to never be grateful** or appreciate anything - only to whinge, complain and demand (**permanent entitled victim**). The common scold.

See **Ressentiment**, Groll, Rancor *“In itself it does not contain a specific hostile intention, but it **nourishes any number of such intentions**” (Friedrich Nietzsche, Max Scheler)*

On the Genealogy of Morality - Document[1887] Rank(20) Author(**Friedrich Wilhelm Nietzsche**) Age(43)
Keyword(Individual Philosophy Morals) https://en.wikipedia.org/wiki/On_the_Genealogy_of_Morality
<http://www.gutenberg.org/ebooks/52319>
<https://archive.org/details/GenealogyOfMorals/page/n1/mode/2up>
<https://www.gutenberg.org/files/52319/52319-h/52319-h.htm> 14.

Will **any one** look a little into—right into—the mystery of **how ideals are manufactured in this world?**
Who **has the courage** to do it? Come!

Here we have a vista opened into these grimy[Pg 48] workshops. Wait just a moment, dear Mr. Inquisitive and Foolhardy; your eye must first grow accustomed to this **false changing light**—Yes! Enough! Now speak! What is happening below down yonder? Speak out that what you see, man of the most dangerous curiosity—for now I am the listener.

"I see nothing, I hear the more. It is a cautious, spiteful, gentle whispering and muttering together in all the corners and crannies. It seems to me that they are **lying; a sugary softness adheres to every sound. Weakness is turned to merit**, there is no doubt about it—it is just as you say."

Further!

"And the **impotence which requites not, is turned to 'goodness,' craven baseness to meekness, submission to those whom one hates, to obedience (namely, obedience to one of whom they say that he ordered this submission—they call him God).** The **inoffensive character of the weak**, the very cowardice in which he is rich, his standing at the door, his forced necessity of waiting, gain here fine names, such as **'patience,'** which is also called **'virtue'**; not being able to avenge one's self, is called not wishing to avenge one's self, perhaps even forgiveness (**for they know not what they do—we alone know what they do**). They also talk of the 'love of their enemies' and sweat thereby."

Further!

"They are **miserable**, there is no doubt about it, all these **whisperers and counterfeiter**s in the[Pg 49] corners, although they **try to get warm by crouching close to each other, but they tell me that their misery is a favour and distinction given to them by God, just as one beats the dogs one likes best;** that perhaps this misery is also a preparation, a probation, a training; that perhaps it is still more something which will **one day be compensated and paid back with a tremendous interest in gold, nay in happiness. This they call 'Blessedness.'**"

Further!

"They are now giving me to understand, that not only are **they better men than the mighty**, the lords of the earth, whose spittle they have got to lick (not out of fear, not at all out of fear! But because God ordains that one should honour all authority)—**not only are they better men, but that they also have a 'better time,' at any rate, will one day have a 'better time.'** But enough! Enough! I can endure it no

longer. **Bad air! Bad air!** These workshops where ideals are manufactured—**verily they reek with the crassest lies.**"

Nay. Just one minute! You are saying nothing about the masterpieces of these virtuosos of black magic, who can produce whiteness, milk, and innocence out of any black you like: have you not noticed what a pitch of refinement is attained by their chef d'œuvre, their most audacious, subtle, ingenious, and lying artist-trick? Take care! **These cellar-beasts, full of revenge and hate**—what do they make, forsooth, out of their revenge and hate? Do you hear these words? Would you suspect, if you trusted only their [Pg 50] words, that you are among men of resentment and nothing else?

"I understand, I prick my ears up again (ah! ah! ah! and I hold my nose). Now do I hear for the first time that which they have said so often: **'We good, we are the righteous'**—what they demand they call not revenge but 'the triumph of righteousness'; what they hate is not their enemy, no, they hate 'unrighteousness,' 'godlessness'; what they believe in and hope is not the hope of revenge, the intoxication of sweet revenge (—"sweeter than honey," did Homer call it?), but the **victory of God, of the righteous God over the 'godless'**; what is left for them to love in this world is not their brothers in hate, but their 'brothers in love,' as they say, **all the good and righteous on the earth.**"

And how do they name that which serves them as a solace against all the troubles of life—their phantasmagoria of their **anticipated future blessedness**?

"How? Do I hear right? They call it **'the last judgment,'** the advent of their kingdom, 'the kingdom of God'—but in the meanwhile they live 'in faith,' 'in love,' 'in hope.'"

Enough! Enough!

A Brief History of Public Service and how to destroy it

Protecting the tribe from animals and attacks from others became the - **Army**.

Conflict/Issue resolution became tribal leader - decision maker - **Leader** and **Judge**.

Record keeping became songs, poems, chants, rituals - **Education** and **Library**.

Houses, Roads, Water, Food, Trade and skills (Agriculture, Farming, Fishing, Building, Soothsaying) developed into an - **Economy**.

Armies have been around for thousands of years and mercenaries for just as long. Your army would fight alongside other tribe's armies not always for reciprocal arrangements - sometimes just for money and possessions.

With the laws and codes being communicated and written down (e.g. Code of Hammurabi) and people being educated enough to read and understand things - this became a tool to reduce the need to constantly judge matters and allowed people to cooperate under the law.

If someone broke the trust of the law then they could be taken before a judge for justice to be done. As long as these things generally held together then the tribe was sustainable.

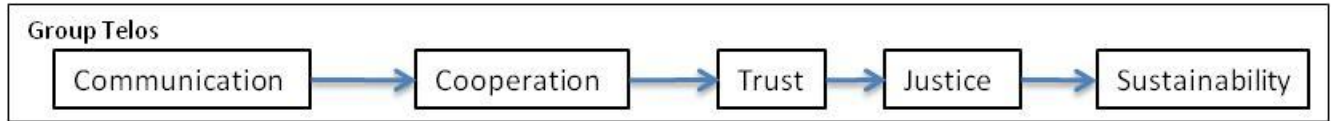

Early public libraries in Athens, Alexandria, Constantinople, Mesopotamia, etc - became places of learning, education, literacy - copying the records. Some paid to be taught by experts (Alexander the great and Aristotle). Socrates lead by example and showed people how to do things. Archimedes invented things and showed people how they worked. Others **became inspired** and creative in their own way.

Thinking, Philosophy, Astronomy, Map Making, grew - even though religious dogma tried to control everything (burn books - sacred texts, the accepted "dogma") - monks throughout Europe, Italy, Turkey and other places - copied books, taught young boys to think, write, learn, and teach others. Writing and books were valued as a public resource. This was possible because of the Economy that the Greek/Romans had created - public roads to be used by everyone for travel, public bridges, water systems, entertainment, sport (Olympic games), taxes, armies (defense), etc.

Oratory, exploration of ideas and difficult issues and debates were public and good speakers were recognized, appreciated and rewarded.

The concept of public service grew - the use of shared facilities - public water, toilets - sometimes paid for - sometimes free - roman baths, spas, entertainment, drama, poetry, songs, music. People learned to cooperate in their use. Talent was rewarded with education, training and opportunity and was passed on to others through generations.

People were responsible for behaving well, they were held to account for their actions, learning developed and grew, they acted **not** out of a desire to be popular (**that way lead to narcissism, paranoia, violence and destruction**) - they wanted to be competent - have a skill - some value to the group - to show some **appreciation** and **gratitude** for the life they had and any opportunities that came their way. (see **Marcus Tullius Cicero** - he was always expressing his gratitude and working to help others in the group - the army kept them safe, the economy allowed all to function, the libraries allowed all to read and develop)

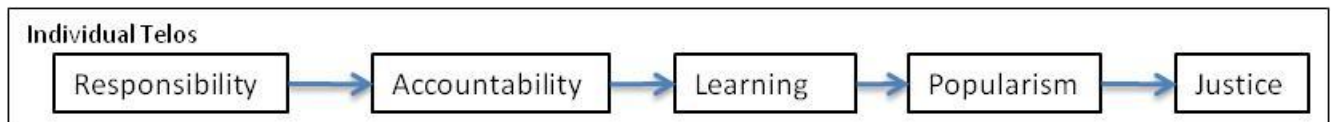

The Public service - especially in Australia - is now fully corrupted. It is so corrupted that people do not even know what corruption is. The very idea of corruption no longer exists - it has been replaced with the "cause" the certain virtue. The "certain ends". There is no longer any concept of "public service" - the sharing for the group - it has been replaced with "self" - self-focus, self promotion, self virtue, and

the individual and group victim and has become a haven for narcissistic psychopathic bullies, liars, virtue signalers, self promoters and bad actors. E.g. the Legal professionals-courts, Politics, Universities, Office of “women”, etc - all public services.

Public services has become cheap virtue signaling of public money to causes, mobs and whingers. Let’s give money to causes. Let’s employ some blacks/women - in some nonsense expensive job.

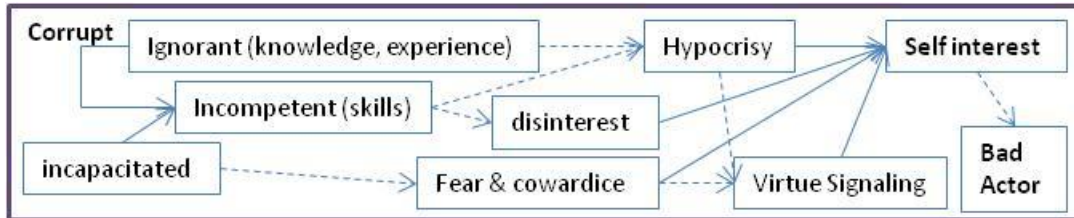

Women now enter the public service based on a notion of being the entitled/victim. They seek to get promoted not based on skill or ability - but based on any technique that works - identity, quotas, threats, blackmail, hoarding corporate knowledge, sexual favours, etc - any amount of “**Bad Acting**” justifies the certain ends - in other words many people who enter the public service are not there to be “a public servant” they are there to promote themselves and get more money - their own **Self Interest**. The job is merely a “means to an ends” more money for themselves and their friends. Everything is framed as “what can I get out of this” - in a totally self interested way.

The concept of “**Permanent Tenure**” of public servants **was designed** to encourage people of good character and talent - with a focus of public service - not themselves and “advancement” for its own sake. Responsibilities and commensurate salary was advanced as skill, demonstrated ability, actual delivery (results) , learning and character grew. People were trained and nurtured into jobs to work as **permanent public servants**. This was seen as **an investment** in the most capable, trained, apolitical and uncorruptable people working on behalf of the group. This was a valued and respected responsible position. Open, Accountable, Transparent and Competent.

TRUST was essential for the group.

Even if the politicians were corrupt you could **trust the public servants** to behave honestly with integrity.

Encouraging people with the wisdom of Solon, Socrates, Aristotle - allowing them to make mistakes - learn, grow and develop new skills and capabilities on behalf of the group.

All inventions belonged to the public service - if you did good work - then that work became part of the collection of good works - it was not your “intellectual property” - your ideas were given freely and encouraged to be debated and discussed - away from the political and corrupt debating frames - things were analyzed and explored in “frank and fearless” ways and not out of appeasement to the tyrant, dictator, cause, feminists, blacks or other mob like groups. **Speaking truth and exploring difficult issues**

was the job - exposing problems was important - although now it is called “Whistle blowing” and has been criminalized by the public service and politicians wish to continue to corrupt the public service.

Slowly the concept on contractors grew. Originally there were few contractors because the public service had all the people with the best skills and talent. Then people entered the public service - deliberately set out to gain skills and knowledge using all the technology, training and opportunities provided for them - and then made friends” with as many people as possible (agreeable and sycophant) so they could then be employed as “contractors” on higher wages and with more “respect”, influence, job opportunities and power. In this way employees effectively promoted themselves - based on convincing people how wonderful they were or deliberately storing essential corporate knowledge in themselves and making themselves the repository of corporate history and skills. The alternative to this approach was to write manuals and other documents to train and help other employees - to transfer corporate knowledge within the organization and encourage debate and discussion about difficult issues. Sycophants grew and the greasy pole climbers sucked up to whatever boss they could find. Contractors demonized public service staff as “ignorant” and “incompetent”.

Fat, Dumb and **Lazy** bosses **forgot about the purpose of the public service** and fell to the habit of “get a contractor in”.

Imagine outsourcing your army to a group of contractors.

Debate and arguments stopped - people stopped learning and developing - collusion and corruption developed - services and capabilities were diminished and destroyed. At one stage the Australian Tax Office was looking to outsource its entire data holding to a computer center in India. Like Australian Accountants who send Australian Tax Records to large TAX processing centers in Asia - because it is “cheaper” and makes more profit for them (regardless of the privacy and security threat issues)

One (of many) examples is AUSTRAC - when they got a Teradata computer. The staff using and learning about the computer developed programs and expertise - using the public service data, resources and technology - and they all banded together to form a group. They then negotiated with AUSTRAC (either corruptly or as blackmail) to be employed as “contractors” - separately from the “public service” thus destroying the concept of public service from within.

We see this in the States of Australia where whole public service agencies like Ambulances, Hospitals, Fire Services, Protection, (not police yet) are “outsourced” to contractors - like “mercenaries” in an army. (compare this concept with the Ukrainian army of dedicated individuals fighting to protect their own country - regardless of the profit motive.)

John Howard, famously in “the night of the long knives”, sacked all the old heads in the public service because they dared to disagree with him or argue the case (highlighting his ignorance).

Now heads of public service are appointed as favours, graft, bribes, corruption to friends, family, political partners or women and blacks as a virtue signal. **Merit no longer exists** - only **corruption**.

Gordon Ramsay fails to get re-elected so Andrew Barr gives him a public service contract. *"They all do it. This the way we do things around here"*

Waste and corruption dominates the public services now - it has become a virtue signaling service and an expensive and incompetent home of deliberately corrupt, untalented, feminists, blacks, etc.

Andrew Barr virtuously creates a "Human Rights" agency to compete with the Commonwealth "Human Rights" agency and gives Helen Watchirs and other Labour party type (his type of people - his tribe) friends "jobs" in the public service - so they can reaffirm the wonderful job Andrew Barr is doing on Human Rights - no matter what he does, how corrupt he is, how much he removes human rights from men and others he wants to target. They concentrate on using correct pronouns with each other while everyone is locked up under "emergency laws" or demonized, fined for "vaccine" and mandated reporting offences.

His personal reaffirmation agency *"Yes Andrew - your truly are a wonderful human being and definitely not a corrupt lying tyrant"*

The **Commonwealth Public Service Act 1999** <https://www.legislation.gov.au/Details/C2019C00057>

(1) *The APS is professional, objective, innovative and efficient, and works collaboratively to achieve the best results for the Australian community and the Government.*

(2) *The APS demonstrates leadership, is trustworthy, and acts with **integrity**, in all that it does.*

(3) *The APS respects all people, including their **rights and their heritage**.*

Here is where the rot and dogma begins - we get undefined rights and "heritage" becomes the new gods rather than people - humans - themselves. BLM, etc. Why not simply - the APS respects all people. Or all citizens? Why include it at all except to highlight the terms Rights and Heritage? Who is going to interpret this exactly?

(5) *The APS is **apolitical** and provides the Government with advice that is **frank, honest, timely** and based on the **best available evidence**.*

(1) *The APS is a career-based public service that:*

(a) *makes **fair employment decisions** with a fair system of review; and*

Fair here has become **corrupted to mean** promotes women and blacks on a quota system.

(g) *recognises the **diversity** of the Australian community and fosters **diversity** in the workplace.*

The **New cause/god** of diversity here has been inserted to **replace the legislation which said "merit based selection"**. Merit has disappeared to be replaced by **"fair- diversity"** This corruption of the Act was lead by Penny Wong, Tanya Plibersik type people in the Labour party and the Greens and agreed to by feminists and virtue signalers in the liberal party. Doublespeak, Newspeak (George Orwell)

2 (e) *the **assessment is the primary consideration** in making the decision.*

So you are fairly assessed (HA!) of being the right diversity. Bulshit.

10A APS Employment Principles

APS Employment Principles

(1) *The APS is a career-based public service that:*

- (a) makes **fair employment decisions** with a fair system of review; and*
- (b) recognises that the usual basis for engagement is as an ongoing APS employee; and*
- (c) makes decisions relating to engagement and promotion that are **based on merit**; and*
- (d) requires effective performance from each employee; and*
- (e) provides flexible, safe and rewarding workplaces where communication, consultation, cooperation and input from employees on matters that affect their workplaces are valued; and*
- (f) provides workplaces that are **free from discrimination, patronage and favouritism**; and*
- (g) recognises the diversity of the Australian community and **fosters diversity in the workplace**.*

Decisions based on merit

(2) *For the purposes of paragraph (1)(c), a decision relating to engagement or promotion is based on merit if:*

- (a) **all eligible members** of the community were given a reasonable opportunity to apply to perform the relevant duties; and*
- (b) an assessment is made of the relative suitability of the candidates to perform the relevant duties, using a competitive selection process; and*
- (c) the assessment is based on the relationship between the candidates' work-related qualities and the work-related qualities genuinely required to perform the relevant duties; and*
- (d) the assessment focuses on the relative capacity of the candidates to achieve outcomes related to the relevant duties; and*
- (e) the assessment is the primary consideration in making the decision.*

Note: Commissioner's Directions may determine the scope or application of the APS Employment Principles (see subsections 11A(2) and (3)).

This is completely incoherent doublespeak. **Merit** now becomes defined and mixed up with **diversity**. **Diversity now becomes merit itself, in fact to be eligible to be selected you must be diverse first before you merit can be tested.** This allows positive discrimination - based on identity characteristics - which works hand in glove with the Discrimination Act to ensure that Discrimination is encouraged and supported - not only in government departments - but public organizations as well. **Discrimination based on identity** as defined under various definitions of diversity (see discrimination Act) **is encouraged over merit and capability.** Penny Wong, Labour and Greens have supported this for decades and actively sought to corrupt every piece of legislation they can.

(2) Without limiting subsection (1), the Commissioner's functions include the following:

(a) to foster, and contribute to, leadership, high quality learning and development and career management in the APS;

(b) to **lead the thinking about**, provide advice on and drive reforms to **workforce management policies** so that the APS is ready for future demands;

(c) to develop, review and evaluate APS workforce management policies and practices and **maintain appropriate databases;**

(d) to **foster an APS workforce that reflects the diversity** of the **Australian population; (ON AVERAGE!!!)**

18 Promotion of employment **equity**

An Agency Head **must** establish a **workplace diversity program** to assist in giving effect to the APS Employment Principles.

Diversity and equity - OF WHAT EXACTLY!!! - AGE, WEIGHT, HEIGHT, SMELL, RACE, RELIGION, FRIENDS, RELATIVES, Disability, Transgender, Sentient pets, Averages?- (whatever that means) are **mandated!** Merit, competence, outcomes, etc - mean nothing.

Compare this to the bullshit of saying that there is a **PRO-INTEGRITY culture** in the APS.

<https://www.apsc.gov.au/working-aps/integrity/integrity-aps/fact-sheet-pro-integrity-culture>

Strengthening integrity culture delivers several benefits to APS agencies by:

producing **better decision-making**

exemplifying high professional standards

enhancing **public trust** in the APS, and

protecting against misconduct.

How can you trust an agency which does not promote people based on merit and capability? - instead it champions diversity and equity gods. A **better decision making framework** would focus on merit not **identity!** Identity - and diversity of - is irrelevant!

APSC Diversity and Inclusion <https://www.apsc.gov.au/state-service/state-service-report-2019-20/chapter-3-your-aps/diversity-and-inclusion>

A commitment under the **APS reform agenda**, the APS aims to **increase diversity** 'so the APS itself

reflects and understands the people and communities it serves, **recruiting more people from outside the APS** and **welcoming different views and perspectives**'

Reflect stupidity, mobs, groupthink, bias and incompetence as well? So we can understand idiots better and communicate better with idiots? "Lived Experience"? - Mandated insanity. Rather than the best most highly qualified people - it reflects the idiocy of society??? Feminists, Nazis, Facists, Communists, Right, Left, Blacks, Jews, Trans, etc - or only the **"right" kind of reflection** based the elites view of groupthink?? - As defined in the **Discrimination Act - How to discriminated against humans**. You corrupt bias binary smuglifunts with your **binary certain (on average)** view of the world. Too stupid to know how stupid you are.

So you would think the mob think, biased, bigoted, lying, corrupt, fuck-wits who are the political elites would advocate for an **"Office of Men"** to balance out the **"Office of Women"** and better **REFLECT** and **UNDERSTAND** the people (**humans - men are human people too**) and **COMMUNITY IT SERVES**.

I know - what about 50% shared custody in Family court to better "reflect" the community.

*Demonstrating diversity is also one way of earning a **social license to operate**, and to **build public trust** in the APS.[139]*

Bullshit and simply wrong. Give me a competent bridge builder rather than black woman diversity appointment or lived experience idiot any time you smuglifunts.

All of this bullshit has been implemented into schools, universities, courts and the public service on a continuing basis since about the 1970's. Race to the bottom - on average.

The social license is TRUST and DEMONSTRATED COMPETENCE not **entrenched, mandated, BIAS, BIGOTRY** and pandering to mobs

But **60% Women** is **NOT A FAILURE TO REFLECT** society - NO **we just need to redefine** what **"reflect"** and **"Equality"** mean - I know, **"Inclusion"** - who needs merit and competence when you have these gods? *Build back better with certain "Inclusion"*.

*"Long-term trends show increasing **diversity**" (praise God) "in the APS, with greater proportions of women, Aboriginal and Torres Strait Islander employees, and those from a non-English speaking background. However, between 2001 and 2020, despite increasing numbers of employees with disability, there has been little change in the **proportional representation**" (Mandated IDENTITY) "within the workforce as whole.[140] Further, representation is about more than just raw percentages in the APS, **it is about diversity among leadership cohorts**, and across different types of roles and job families.*

APSED data for the 12 months to 30 June 2020[141] shows:

women occupy 60% of roles in the APS, following a long-term trend unfolding over the past 50 years
a small drop in the representation of Aboriginal and Torres Strait Islander employees to 3.5%, despite long-term growth from 2.9% in 2001 to 3.6% in 2019

a small increase in the representation of employees with disability to 4.0% (up from 3.9%), but stagnant over the long-term

the number of employees from a non-English speaking background remained relatively stable."

Good news - who needs outcomes and performance - when just being Black or a Woman is enough?

The Social Contract & Discourses - Document[1761] Rank(10) Author(Jean-Jacques Rousseau) Age(49)
Keyword(Individual Philosophy) <http://www.gutenberg.org/ebooks/46333>
<https://archive.org/details/therepublicofpla00rousuoft/page/n5>
<https://oll.libertyfund.org/titles/rousseau-the-social-contract-and-discourses>

*"In order then that the social compact may not be an empty formula, it tacitly includes the undertaking, which alone can give force to the rest, that whoever refuses to obey the general will shall be compelled to do so by the whole body. This means nothing less than that he will be **forced to be free**; for this is the condition which, by giving each citizen to his country, secures him against all personal dependence. In*

*this lies the key to the working of the political machine; **this alone legitimises civil undertakings, which, without it, would be absurd, tyrannical, and liable to the most frightful abuses.***"

*"Every service a citizen can render the State he ought to render as soon as the Sovereign demands it; but the Sovereign, for its part, **cannot impose upon its subjects any fetters that are useless to the community**, nor can it even wish to do so; for no more by the **law of reason** than by the law of nature can anything occur **without a cause.**"*

*"From whatever side we approach our principle, we reach the same conclusion, that the **social compact** sets up among the citizens an equality of such a kind, that they all bind themselves to **observe the same conditions and should therefore all enjoy the same rights**. Thus, from the very nature of the compact, every act of Sovereignty, i. e. every authentic act of the general will, binds or favours all the citizens equally; so that the Sovereign recognises only the body of the nation, and draws no distinctions between those of whom it is made up. What, then, strictly speaking, is an act of Sovereignty? It is not a convention between a superior and an inferior, but a convention between the body and each of its members. It is legitimate, because based on the social contract, and equitable, because common to all; useful, because it can have **no other object than the general good**, and stable, because guaranteed by the public force and the supreme power. So long as the subjects have to submit only to conventions of this sort, they obey no-one but their own will; and to ask how far the respective rights of the Sovereign and the citizens extend, is to ask up to what point the latter can enter into undertakings with themselves, each with all, and all with each."*

The public service is not serving the **public good** to "reflect" Society - it is required to serve the public en masse - to **do things** rather than to **be something** - to **merely exist** as an **identity statistics** database.

*"When I say that the object of laws is always general, I mean that law considers subjects en masse and actions in the abstract, and never a particular person or action. Thus the law **may** indeed decree that there shall be privileges, but cannot confer them on anybody by name. It **may** set up several classes of citizens, and even lay down the **qualifications for membership of these classes**, but it cannot nominate such and such persons as belonging to them; it may establish a monarchical government and hereditary succession, but it cannot choose a king, or nominate a royal family. In a word, no function which has a particular object belongs to the legislative power."*

*"Laws are, properly speaking, only the conditions of **civil association**. The people, being subject to the laws, ought to be their author: the conditions of the society ought to be regulated solely by those who come together to form it. But **how are they to regulate them?** Is it to be by common agreement, by a sudden inspiration? Has the **body politic** an organ to declare its will? **Who** can give it the foresight to formulate and announce its acts in advance? Or how is it to announce them in the **hour of need?** How can a **blind multitude**, which often **does not know what it wills**, because it **rarely knows what is good for it**, carry out for itself so **great and difficult an enterprise as a system of legislation?** Of itself the people wills always the good, but of itself it by no means always sees it. The general will is always in the right, but the judgment which guides it is not always enlightened. It must be got to **see objects as they are**, and sometimes as they ought to appear to it; it must be shown the good road it is in search of,*

secured from the seductive influences of individual wills, *taught to see times and spaces as a series*, and *made to weigh the attractions of present and sensible advantages against the danger of distant and hidden evils.*"

George Santayana/Jorge Agustín Nicolás Ruiz de Santayana y Borrás - Lifespan[1863 to 1952]

Born_Loc(Madrid, Spain) Rank(80) Keyword(Philosophy)

https://en.wikipedia.org/wiki/George_Santayana <https://www.gutenberg.org/files/15000/15000-h/15000-h.htm> https://en.wikiquote.org/wiki/George_Santayana , <https://santayana.iupui.edu/>

The Life of Reason - Document[1906] Rank(20) Author(**George Santayana**) Age(43) Keyword(Group Development Philosophy) https://en.wikipedia.org/wiki/The_Life_of_Reason

<https://www.gutenberg.org/files/15000/15000-h/15000-h.htm> <https://santayana.iupui.edu/text/>

"The intelligent man known to history nourishes within a dullard and holds a lunatic in leash. He is encased in a protective shell of ignorance and insensibility which keeps him from being exhausted and confused by this too complicated world; but that integument blinds him at the same time to many of his nearest and highest interests. He is amused by the antics of the brute dreaming within his breast; he gloats on his passionate reveries, an amusement which sometimes costs him very dear. Thus the best human intelligence is still decidedly barbarous; it fights in heavy armour and keeps a fool at court."

THREE PHILOSOPHICAL POETS LUCRETIUS, DANTE, AND GOETHE **George Santayana** Based on the text originally published in 1910 <https://santayana.iupui.edu/wp-content/uploads/2020/06/TPP.pdf>

"INTRODUCTION THE sole advantage in possessing great works of literature lies in what they can help us to become. In themselves, as feats performed by their authors, they would have forfeited none of their truth or greatness if they had perished before our day. We can neither take away nor add to their past value or inherent dignity. It is only they, in so far as they are appropriate food and not poison for us, that can add to the present value and dignity of our minds. Foreign classics have to be retranslated and reinterpreted for each generation, to render their old naturalness in a natural way, and keep their perennial humanity living and capable of assimilation. Even native classics have to be reapprehended by every reader. It is this continual digestion of the substance supplied by the past that alone renders the insights of the past still potent in the present and for the future. Living criticism, genuine appreciation, is the interest we draw from year to year on the unrecoverable capital of human genius."

Scepticism and Animal Faith - Document[1923] Rank(80) Author(**George Santayana**) Age(60)

Keyword(Group Development Philosophy)

https://openlibrary.org/books/OL7090938M/Scepticism_and_animal_faith

https://en.wikipedia.org/wiki/Scepticism_and_Animal_Faith

<https://archive.org/details/scepticismandani00santuoft/page/n5/mode/2up> *"It may be observed in passing that no logic to which empire over nature or over human discourse has ever been ascribed has been a cogent logic ; it has been, in proportion to its exemplification in existence, a mere description, psychological or historical, of an actual procedure ; whereas pure logic, when at last, quite recently, it was clearly conceived, turned out instantly to have no necessary application to anything, and to be merely a parabolic excursion into the realm of essence."*

“CUSTOM does not breed understanding, but takes its place, teaching people to make their way contentedly through the world without knowing what the world is, nor what they think of it, nor what they are. When their attention is attracted to some remarkable thing, say to the rainbow, this thing is not analysed nor examined from various points of view, but all the casual resources of the fancy are called forth in conceiving it, and this total reaction of the mind precipitates a dogma ; the rainbow is taken for an omen of fair weather, or for a trace left in the sky by the passage of some beautiful and elusive goddess. Such a dogma, far from being an interpenetration or identification of thought with the truth of the object, is a fresh and additional object in itself. The original passive perception remains unchanged ; the thing remains unfathomed ; and as its diffuse influence has by chance bred one dogma to-day, it may breed a different dogma to-morrow. We have therefore, as we progress in our acquaintance with the world, an always greater confusion. Besides the original fantastic inadequacy of our perceptions, we have now rival clarifications of them, and a new uncertainty as to whether these dogmas are relevant to the original object, or are themselves really clear, or if so, which of them is true.”

The Gift of the Virtue Prayer

Remember the Jews - Black lives matter - Women are entitled victims - Victims - Equality - Diversity - Inclusion (in logical order)

Say the prayer every day - to each other. Signal your virtue and build the mob.

Praise be to the one who gives us the certain prayers. I **feel** better now. My virtue grail is filling every day.

Oh Zarathustra - you are so wise - please give me more certainty so I do not have to think, engage, discuss or argue my smuglifuntism.

*Oh, God of certainty, you are so great - **tell who I must smite** to save the world.*

We all, like Sheep. (Handel Messiah)

The Case of the Next BLACK FEMALE judge

Isn't about time we have a black woman judge says the president of the United States. Virtue signal groupthink, corruption, nepotism - feminism and tribal incoherence. Think all the female and black appointments, money and gifts in recent times by weak minded governments around the world - USA, Australia, UK, Canada, NZ - for the last 50 years - identity and virtue signaling, not talent has governed appointments in courts, public service, politics, universities, boards, charities, schools, army, police, media, etc.

Then everyone gets to ask her questions to see what her skill set is and how biased she is. Is she worthy?

“Can you define a Woman?” - she is asked.

“I am not a biologist” - She says. (It requires a highly paid expert to judge who is a woman and in her court there would be a long list of highly paid experts debating (**expensive dogmatic certainty - in a binary kind of way**) whether a person was a woman or not under the legislation and therefore entitled to all the benefits that the government has mandated for women under the guise of positive discrimination for women and other forms of gendered bias and corruption)

So no-one in the current commentators around the world notice this. Not one.

The incoherence goes un-noticed as the feminists and weak minded-men all nod and agree.

SO THE VERY NEXT QUESTION SHOULD BE:

Do you consider yourself a Black Woman - and therefore meeting the President’s MANDATED selection requirements?

“who am I to say?” - she might say (in a victim of the question type of identity politics method)

Is the president insane? (Who am I to say - I am just following orders - everyone does it - it is the way we do things around here)

The main selection criteria for this job is being a black woman - can you prove you are a Black Woman and thereby qualified for this job?

Imagine if the president said “The next Judge I appoint will be a WHITE MALE.”

Obvious bias and corruption is celebrated by USA, UK, Canada, NZ and Australia and any argument against it is ignored, cancelled or attacked. “Office of Women (and their children)”, “Respect” - promote more women, promote more blacks, promoted sons and daughters of MY tribe/My family/My Friends/My Donors - My constant corruption and **destruction of society** - destruction of capability - destruction of competence - destruction of skills - destruction of interest - destruction of learning - destruction of justice - destruction of trust - destruction of cooperation - destruction of communication - destruction of sustainability.

Imagine you are offered a Job and they tell you they reason you are being selected is because you are white male. **Would you accept the job offer?** Would you say **“I refuse to be employed as a token or a statistic”**.

What does integrity look like - do you think????

Of course the women in the Australian High Court think integrity looks like more women judges - they say as much and all the women lawyers support them - men should be tried by women judges - women should be tried by women judges they declare. **Gender MATTERS to judges**. This lack of integrity is entrenched - **complete corruption and delusion** by the Australian Legal class - in all courts - all lawyers - all barristers - all politicians - now fully dominated by feminists and weak minded male sycophants. Like the media, like politics, like universities, like schools, etc.

See **Women Lawyers – Corruption – Feminism – Debate** - <https://humanistman.com/wp-content/uploads/2020/07/Women-Lawyers-Corruption-Feminism-Debate.pdf> **“Deep cultural shifts in how men treat women in the law are required,”** stated as deliberately bigoted, mobthink, bald, unsupported, biased and unbalanced fact “ *as well as reforms to prevent the manifestations of what many fear*” **(women’s anxiety rather than analysis or facts)** “ *may be institutionalised sexism* ”

BY WHO EXACTLY?? A

GROUPTHINK/MOB? Identity or individual cases which are extrapolated to THE GROUP IDENTITY???? “*that has allowed this culture to continue. We must reach a position*

where all people, regardless of their sex, sexual orientation, gender identity, intersex status, age, race, ethnicity, or disability ” **Official legislated dogmatic list of**

identity characteristics which dogmatically certainly define in a groupthink way

“DIVERSITY” (the new god) - who needs talent when you have diversity (on average) HEY!!!!

“are treated with equal professional dignity. ”

WHY SHOULD ANYONE BE TREATED WITH DIGNITY IF THEY WERE APPOINTED BASED ON GENDER AND SKIN COLOUR? It undermines “Respect” and TRUST - DON’T YOU THINK!!!!

*“shortlisting **must occur** against criteria that are set out in a public statement, and must include legal knowledge, skill and expertise in addition to essential personal qualities (eg integrity and good*

*character). The **value of diversity”** (Praise be - new daily prayer - to goodness) *“in judicial**

appointments should also be respected. The Australasian Institute of Judicial Administration’s Suggested Criteria for Judicial Appointments provides an example of such a statement” -

widespread institutionalized corruption, bias and delusion

I was arguing this Black Woman Judge thing with a guy at golf. He said it is all about the public service “Reflecting” society. (The Ends Justifies the Means) - What Ends? For What purpose? He refused to describe what he thought “Reflected Society” meant. He doubled down and refused to debate, explore or discuss. More than 70% of people cannot think, discuss or debate anything - they only want their **SMUG CAVE OF DELUSIONS** to be re-enforced. (*See how strong my smug virtue is?*) Penny Wong stare - Richard Marles “with respect”, BLM “Take the knee”, Sam Grant “Leave the room - with respect”, etc. **How dare you ask me to explain myself!!**

So the idea of quotas (binary extremism) is **dividing all of people into designated groups** and tribes by characteristic - identity- skin colour/gender/language/belief/disability - (Diversity characteristics as defined in dogmatic legislation) - is tyrannical, bigoted, authoritarian **TOTALITARIANISM** (see Australia’s Discrimination Legislation i.e. HOW TO DISCRIMINATE - Office of Truth, Office of certain Human Rights, “Truth Telling”, etc).

Then **every job is decided on statistics** (ON AVERAGE) *isn’t about time* (our turn) to have a black, disabled, Jewish, Chinese, trans woman as the next high court judge.

This is seen as the idea of the public service - filling positions based on identity and **not talent or ability**. It is considered a crime (discrimination AS LEGISLATED) to employ someone based on ability. In fact legislation INSISTS that you must discriminate in Favour of designated identity groups and you do not even have to justify it or end it (the end date and justification requirements have been removed from legislation by Penny Wong, Tanya Plibersik, the Greens and the other man hating feminists). No reason or sense is required. The Group is allowed to **discriminate against** is MEN - as legislated - and they do this all the time. See <https://humanistman.com/home/articles/> **Humanism Issue – Nation Law – Exceptions – Religion and Groups. None of this is secret. It is joyfully celebrated by Labour and the Greens. “Progress”**

THE VERY DEFINITION OF CORRUPTION. Biased and unfair selection/decision process on behalf of the group MANDATED in universities, public service, politics, political parties, schools, media, charities, sport, courts, etc.

Framing Shaming Avoiding and Abusing

How dare you ask this question at this time. This is not the time to ask these questions.

Death of Kimberly Kitchen - Allegations of Bullying by Labour party women

How dare you suggest Magistrate Cook is ignorant, corrupt, a narcissist and psychopathic.

How dare you suggest the A.C.T. Chief Magistrate Walker is a man hating feminist.

How dare you suggest the court is corrupt. Your whistleblowing accusation is a threat to our national security.

*How dare you suggest that Women lie. (Graham Perrett said words to that effect in parliament - expressing his outrage that anyone could think that women lie and that that person could be appointed to a committee looking into family law). **Humans lie**, Graham. Graham walks in BLM “protests” signaling his support for lies, groupthink, mobs, virtue and hypocrisy (likes most Labour Green types) and how easily he is manipulated for his “virtue” by bad actors.*

*How dare you question me (Andrew Leigh in a public town hall meeting) when we are proud we have 50% women in the Labour party - see - we are not misogynists and bigots - we don't discriminate - it is you who hate and women and discriminate against women, blacks and jews - we don't discriminate and we can prove it - We have 50% women by quotas (active discrimination - the **“right kind” of discrimination and bigotry** - not the “wrong” kind like you). We love inclusion so much we have 70% women in some of our agencies- see how inclusive we are!*

How dare you suggest the Emperor has no clothes!

Richard Marles (Labour Party Male non-entity and public sentient pet sacrificial eunuch for the Labour Party and Green Feminist cause) *“With respect”* he says to the reporter in an effort to frame and shame them using the positioning method (I know better than you - who do you think you??? are asking that question). He does not have the practiced abusive stare that Penny Wong has developed over the decades but he is working on it following her example. *“With Respect”* - (I know better than you - isn't about time you behaved yourself). Respect for WOMEN (the commonwealth respect legislation rammed down the young minds of primary school children) *“we need to respect women and the memory of women - SO this allows me to pull out the positioning model whenever I like.”* *“With respect for WOMEN”* (the certain god) - *“you should not ask this question”*.

“With respect for whatever I tell you to respect” - I will tell you what to think and you will believe anything I say because I know what must be respected (Me and my view of the world).

This is Russian, Chinese, USA, UK, Canadian, NZ tyrannical dictators - this is Labour, Greens, Feminists.

Framing, shaming and abusing is usually done by underdeveloped humans on “others” in a binary groupthink kind of way. They can end up being Bad Actors and will lie, cheat, steal, incite mob actions, verbally and physically abuse anyone who attacks them and their underdevelopment. Think the constant **“common scold”** https://en.wikipedia.org/wiki/Common_scold of the smuglifunts at the ABC and the Labour and Greens men and women - constant personal attack and groupthink. Also see my human frame <https://humanistman.com/wp-content/uploads/2019/06/11-Humanism-Corruption-Hypocrisy.pdf> **Page 3 introduction Narrative** *“There are many forms of Bad choices. When this repeats it becomes behavior (pattern). Repeated Bad behavior can vary in frequency. When humans frame Bad behavior in an unevolving model then **they no longer learn** - they become stuck.*

*An individual human or subset of a group who knowingly makes Bad choices on behalf of a group using an **incoherent and unevolving frame have corrupted the choice process**. It is corruption.*

*Bad choices can be made by Humans - **human development** is corrupted **when nothing is learned** and no **improved information** is used for future choices. This lack of learning and development impacts **human survival**.*

*Hypocrisy is one behavior which corrupts human development and is usually done by **insecure and confused humans**. They may not realize that they are developing a consistent frame for decision making or they or have a state of mind where **self consistent choice making frames** have not yet or will never develop.*

*The hypocrisy exposes itself when a **human consistently argues a frame for decision making choices and then swaps it when another choice arises**. This, they argue, is having a number of different decision making frames for choices and that they – the individual human – is best suited to choose.*

They invest themselves with special power on behalf of the group. They champion incoherence.

*Hypocrisy usually arise when individuals are **faced with challenging choices** which affect their decision making frame. (We will ignore undeveloped humans at this stage). Because **resistance to change***

*(inertia) (Fat, Dumb and Lazy) is built into humans they will often **discard the choice making frameworks** development for something else – none, senses, ignorance, lack of development and inbuilt incoherence. **They disdain any need for a developing coherent choice making frame.***

Choice is difficult and for many people the world is (simply) too complex. “Anything other than having to think”

This breakdown of coherent frames for choice leads to many forms of corruption and all that flows from it** – <https://www.transparency.org/glossary> . Reflect on this - if you can't have a coherent developing frame for choice then why have one at all? **Just do what you like whenever you like?

Hypocrisy is not a new problem, nor is developing accepted and agreed frames for choice for groups

We see many examples of this every day - especially from politicians, courts, media (ABC), universities, schools - it is widespread in all cultures - usually by people blaming and shaming others. The Greens and Labour party - especially the women and weak-minded men who dominate will say “*Now is not a good time to look at allegations of bullying behaviour*” - when allegations emerge of a culture of WOMEN bullying other WOMEN in the Labour party. The reason this is getting current attention is because a woman from the Labour party who died recently from a heart attack accused other WOMEN in the Labour party of abusing and harassing her.

So then some pissed off women psychopath chooses the same time to make allegations against the “others” - the other side (This is standard technique used in all arguments) - “*so if you will not investigate allegations against you/your group why should we investigate ours?*” This falls into the category of the **race to the bottom** (cascading through binary trees) based on a general allegation of “hypocrisy” usually involving the “**false equivalence**” technique (binary thinking) - “*You also lied once so why shouldn't I lie all the time?*” OR “*You cannot prove you are telling the truth - so that means I can lie all the time*” (**Bad Actor** - Delusional Psychopaths- ABC, Feminists, Binary extremists, Women (on average), weak minded men, etc) “*They are both as bad as each other*” “*They are the same*” .

Aristotle seems not to have dealt much with this argument/debating technique

<https://plato.stanford.edu/entries/aristotle-rhetoric/> - it might be “ad hominem” - a kind of **instant reflex response** to any allegation - a “fight” **rather than a debate or discussion** of a real or perceived problem. See Farnham Street blog <https://fs.blog/bad-arguments/> . Also too, it has much to do with **tribal warfare, Prisoner's dilemma** and **Game theory**. These techniques are all about avoidance of any investigation and fobbing off and doubling down on any feedback or criticism (opportunity to learn and develop). Aristotle has already assumed/taken for granted (and hence seems to have not closely examined this kind of counter allegation attack technique) that there is **some kind of fair judge** or appointed judge “*various magistracies*” to examine allegations and gives us some of his thinking in the history of Draco and Solon in “**THE ATHENIAN CONSTITUTION**” <https://www.gutenberg.org/files/26095/26095-h/26095-h.htm> . Aristotle also lays out much of his logic in “**The Categories**” <https://www.gutenberg.org/cache/epub/2412/pg2412.txt> “*Qualities admit of variation of degree. Whiteness is predicated of one thing in a greater or less degree than of another. This is also the case with reference to justice. Moreover, one and the same thing may exhibit a quality in a*

greater degree than it did before: if a thing is white, it may become whiter.” - he attempts to describe a structure for language and logic and describes many of the structures I have described in my **14 Humanism – Language Development, Version 1, date 06/10/2019** <https://humanistman.com/wp-content/uploads/2019/10/14-Humanism-%E2%80%93-Language-Development.pdf> . Here he is making a distinction between binary and opposite into “*differentia*” and “*degrees*” of difference using “justice” as an example - a kind of logical conceptual link (which is part of the general problem of **linking two things** of ANY thing declared or described) - but significantly - he recognizes “**discrete or continuous**” (Binary) for “Quantity” **without recognizing** the initial self-reference, recursion problem. E.g. continuous continuums.

An Aside: The unbounded chaotic universe - (based in my view of the initial self-reference, recursion problem) seems to have been **FIRST understood** from **Anaximander** and later, **Heraclitus of Ephesus**, as far as we can tell from the written record. Anaximander seems to also have understood transfinite concepts (bounded infinities). The importance of this is that many others do not grasp this concept and insert **various versions of certainty** at mathematical or philosophical level as an alternative to that view. “*In the beginning*” is a comfortable and soothing notion to many people but is at odds with an unbounded chaotic universe. An alternative might be “*transfinitely in the beginning*” or “*I am declaring (is) a starting point*”. Pythagoras understood many things but stopped developing at a certain point in his life and become **too smug in his certainty** and he and his followers were “driven out of town”.

Anaximander - Lifespan[-610 to -546] Born_Loc(Miletus, Ionia, Turkey) Rank(20) Keyword(Astronomy, Philosophy) <https://iep.utm.edu/anaximander/> <https://en.wikipedia.org/wiki/Anaximander> <https://en.wikipedia.org/wiki/Apeiron>

Pythagoras - Lifespan[-570 to -495] Born_Loc(Samos) Rank(1) Keyword(Math) <https://en.wikipedia.org/wiki/Pythagoras> <https://plato.stanford.edu/entries/pythagoras/> <https://www.ancient.eu/Pythagoras/>

Heraclitus of Ephesus - Lifespan[-535 to -475] Born_Loc(Ephesus/Selcuk) Rank(1) Keyword(Philosophy, Humanism) <https://en.wikipedia.org/wiki/Heraclitus> <https://plato2051.tripod.com/heraclitus.htm> <https://iep.utm.edu/heraclit/>

Solon’s changes to Dracos laws followed a long period of the **Greek Dark Ages** https://en.wikipedia.org/wiki/Greek_Dark_Ages where it seems that the Military made themselves the elites - **possibly (no-one knows for sure)** because they had defended and built up the city of Athens out of the dark ages and had entrenched their power in the laws, judgments and constitution - pretty much like we see with the feminists in politics, courts and the public service today. Corruptly grabbing more power, money and entitlements and fining, damaging, enslaving those who disagree or complain. Solon was popular, educated, a lover of wisdom and **gained respect** from the community. They all knew things were going downhill and getting worse in the city. Eventually he re-wrote the Athenian laws and systems and helped establish a new era of prosperity for all the city. Although the Code of Hammurabi https://en.wikipedia.org/wiki/Code_of_Hammurabi predates Solon by 1200 years - both seem to contain **ideas of fairness**, some **degrees of freedom** and common sense - “*Moreover, since the laws*

were not drawn up in simple and **explicit terms** (but like the one concerning inheritances and wards of state), disputes inevitably occurred, and the **courts had to decide in every matter**, whether public or private. Some persons in fact believe that **Solon deliberately made the laws indefinite**, in order that the **final decision might be in the hands of the people**. This, however, is not probable, and the reason no doubt was that it is **impossible to attain ideal perfection when framing a law in general terms**; for we must judge of his intentions, not from the actual results in the present day, but from the general tenor of the rest of his legislation. “ - they were generally accepted “I gave to the mass of the people such rank as befitted their need, I took not away their honour, and I granted naught to their greed; While those who were rich in power, who in wealth were glorious and great, I bethought me that naught should befall them unworthy their splendour and state; So I stood with my shield outstretched, and both were safe in its sight, **And I would not that either should triumph, when the triumph was not with right.**” - whereas Draco’s laws were seen as biased, cruel and harsh - and empowering the “elites”

https://www.worldhistory.org/Dracos_Law_Code/ - **very much like we see now** in all the feminists (**Entitled/Victim/Elite**) laws and government organizations displayed as **obvious corruption, bias** and dogmatic detail - Family Law, Domestic Violence law, “Office of Women”, CSA, “respect”, Donations, public service appointments, Grants, ABC, Universities (Positive discrimination), Schools, “Black Judges”, courts, Police Action, public service, Public Grants of money and resources to women and blacks, etc.

Now, the context to this bullying/victim allegations is that Australians are trained and **indoctrinated by the feminist narrative** “Women are Victims - men are perpetrators” - which is run in all schools and universities as the commonwealth and state government sponsored “Respect” campaign, “Keeping Women and THEIR children safe” (Women kill their children and themselves all the time - where is the “Safety” in that? - OH THAT’S RIGHT, I FORGOT - women are mentally ill (If they are accused of anything - they were stressed or under pressure, it was a mistake, I promise not to do it again, I apologize (Says Penny Wong)) and it’s a Tragedy (POOR WOMAN) - Men are EVIL PERPETRATORS), the “White Ribbon Cause” (in public service, courts and the legal profession) and the ABC constant media reporting of feminist agenda stories - women are victims, men are perpetrators. So even the most dim-witted Australian notices and apparent hypocrisy of always attacking men who are accused of any type of bad behaviour - even removing them from office until an enquiry is held - to the idea that when a woman is accused of behaviour there is *“nothing to see here”*.

Even some of the under-developed humans are starting to notice the hypocrisy. What? - A WOMAN accused of Bad behaviour against another WOMEN - how could this be possible??? they ask themselves. Then they are faced with the question of **Hypocrisy** as the Labour party men and women all double down and try to SHAME and BLAME anyone who dares to ask the question - to **expose the hypocrisy**.

“I am only a hypocrite when it suits me - how dare you question my authority” - says the tyrannical psychopath. (Kenny, Southpark - created by Trey Parker and Matt Stone)



When you see Penny Wong, Magistrates in Canberra (the legal profession generally), the feminists in the Labour Party and Greens, ABC, Black activists, binary extremists, Chinese, Russian and other tyrannical dictators - you are seeing the **delusional narcissistic psychopath** - their reality - their lived experience - their lies - the “truth” - the unbounded belief in themselves , their view of the world, their “reality”. You

see this in the “celebrity” commentator - not really an analyst gazing into the complexity of the wider universe - more of an ANAList - gazing into the brilliant starshine of their own reflection.

We see widespread open corruption in society now - all the states, politicians, the media, schools, police, business, courts - especially the legal profession as they constantly declare **alleged bad behaviour of everyone else (glass houses, stones)** as a major problem which **needs instant attention** (Domestic violence laws - orders are made immediately on application when the man is not even told there is an application against him, family court as interim orders are made to remove children from their fathers and give the house and assets to the women, police actions and arrests, etc) and government and legal intervention **into their own bad behaviour is non-existent or a performance piece**. They lie to everyone, hide their lies and attack others who expose their lies and hypocrisy. The legal community scumbags work on their behalf - for large sums of money - to run “defamation” cases. How dare anyone suggest “I am a hypocrite or a liar - have you no **shame**”? “Don’t you know who I am?” - says the Emperor - deluding themselves about the “clothes” they wear.

As Russia invades Ukraine and bombs, shoots and kills unarmed and defenseless humans hiding in shelters we see the same **INDOCTRINATION** - the permanent state of hypocrisy and incoherence - based around the **DEMONIZATION OF OTHERS** using **false allegations** in this case the “Evil NAZI like Ukrainians” like the “EVIL MEN” the feminists use or “THE WEST” that China, Iran and Russia use as their permanent victim/perpetrator narrative. All of “the group” are alleged Nazis if One Nazi exists - the false allegation, the lie, the demonization technique - “tared with same brush”, “Far right extremists”, “Deniers”, “They are all the same” “All Jews are the same”, “All blacks are the same”, “All women are the same” “If one victim exists then we are ALL VICTIMS”, “All heretics are the same”. 70% of the Russian population support the Russian dictator and the murders of Ukrainians - just like the support for feminist and black movements here - they go along with the abuse and propaganda. They feel virtuously righteous about their abuse.

Essentially, this is like the arrangement of a **BLOOD SPORT** (Nyah, Nyah - look at all the “Justice” being done say the **smug, self-righteous mobs**) type activity of killing certain humans by group identity - Jews, Christians, Heretics, White Men, Asians, Black - “*Burn Them at the Stake!*” - GROUPTHINK - the “OTHERS” as **incoherent groupthink** and hypocrisy (why not simply kill all people - the **ultimate nihilist** - why have any laws or rules? - **why not just be fully tribal all the time? - and call it “justice”**).

People are **GROUPED** and THEN **ABUSED** - Feminism, Communism, Socialism, Fascism, Popularism, - women on average - think groupthink and quotas and weak minded men - usually playing the drama triangle as “Heroes” (Think the weak minded magistrates and registrars in the A.C.T. Magistrates court, “White Ribbon”, “Respect”, politicians, ABC board management and staff, School teachers, etc).

This constant lying we see in feminists, ABC, politicians, others - the **false victim narrative** - the invented domestic violence allegations, the allegations against an alleged perpetrator - has been considered a crime for thousands of years https://en.wikipedia.org/wiki/Code_of_Ur-Nammu *If a man appeared as a witness, and was shown to be a perjurer, he must pay fifteen shekels of silver. (25) If a man appears as a witness, but withdraws his oath, he must make payment, to the extent of the value in litigation of the*

case. (26) https://en.wikipedia.org/wiki/Code_of_Hammurabi
[https://en.wikisource.org/wiki/The_Code_of_Hammurabi_\(Harper_translation\)](https://en.wikisource.org/wiki/The_Code_of_Hammurabi_(Harper_translation)) The first laws are made about LYING. There were consequences for making false allegations OR allegations WHICH COULD NOT BE PROVED.

1. If a man bring an accusation against a man, and charge him with a (capital) crime, but **cannot prove it**, he, the accuser, **shall be put to death**.
2. If a man charge a man with sorcery, and **cannot prove it**, he who is charged with sorcery shall go to the river, into the river he shall throw himself and if the river overcome him, his accuser shall take to himself his house (estate). If the river show that man to be innocent and he come forth unharmed, he who charged him with sorcery shall be put to death. He who threw himself into the river shall take to himself the house of his accuser. (this seems to be the basis for the Monty python sketch about the witch in the Life of Brian)
3. If a man, in a case (pending judgment), bear **false (threatening) witness**, or **do not establish the testimony that he has given**, if that case be a case involving life, that man **shall be put to death**.
4. If a man (in a case) bear witness for grain or money (as a bribe), he shall himself bear the penalty imposed in that case.
5. If a judge pronounce a judgment, render a decision, deliver a verdict duly signed and sealed and afterward alter his judgment, they shall call that judge to account for the alteration of the judgment which he had pronounced, and he shall pay twelve-fold the penalty which was in said judgment; and, in the assembly, they shall expel him from his seat of judgment, and he shall not return, and with the judges in a case he shall not take his seat.

Extract from my article <https://humanistman.com/wp-content/uploads/2021/04/Responsibility-Accountability-Learning-Popularism-Justice.pdf>

Toxic Culture Narrative. This narrative run by Greens women and feminists is that there is a “Toxic” culture. This the groupthink and mobthink language – like when the Leader of the Labour party said when a woman was killed and they were all having a candlelit vigil <https://www.sbs.com.au/news/we-all-want-to-do-better-parliamentary-vigil-held-for-hannah-clarke-and-children> **“We have all failed, particularly men** have failed, the **women and children** of this country,” he said. He refuses to acknowledge that women have responsibility and accountability for anything and he implies that CHILDREN belong to women and that **women do not kill children** – only men do. What **Anthony Albanese** does not seem to realize is that people are individuals and responsible for their own behavior and that the idea of assigning GROUPTHINK categories is exactly what NAZI Germany did. Anthony supports group categorization – yet he himself is never part of anything other than the “right” group. The ones who are going to “fix” things (hero) – not the “others” (perpetrators) and save victims. If there **was a toxic culture** it is this very binary certain groupthink which smug, sanctimonious politicians deliver from their sermon mount to the “rest of us” about how wonderful they are.

Of course we see the **"Toxic"** individual females of the Labour party and greens - the man hating feminists and their weak minded male sentient pets - determined not admit anything, not to make mistakes, not to be wrong - to deny everything all the time - to deny reality. They cannot take responsibility for anything and are never accountable - they never make mistakes and therefore can never learn anything or develop - they have puffed themselves up as "too big to fail" - they are "Super human" "Uber human" "Special Human". This allows them to berate , bully, harass, laugh at, demean, chortle, sneer, smirk, brow beat, say "how dare you question me", "out of respect TO ME I will ignore any question" (Richard Marles), etc - like little girls in the schoolyard plotting to embarrass, be-little, trick, **frame**, prank, attack, gang-up on (MOB LIKE) on individuals they target. They call this "the rough and tumble of politics" - **not** narcissistic, abusive, self-centered, "ends justifies the means", "They all do it" (race to the bottom), unproductive corruption.

"I'm not a bully" rants Penny Wong into the void. *How outrageous that this even be suggested. I deny everything* say the Greens and The Labour party.

Everyone was kicking the Jews - I just went along with the mob - I am not responsible or accountable. I was only driving the train to Auschwitz" - "we are all just as bad each other" - "they all do it" - they all say.

Hannah Arendt - <https://www.newyorker.com/magazine/1963/02/16/eichmann-in-jerusalem-i> **"Justice demands** that the accused be prosecuted, defended, and judged, and that all the other questions, though they may seem to be of greater import—of **"How could it happen?"** and **"Why did it happen?"**, of **"Why the Jews?"** and **"Why the Germans?"**, of **"What was the role of other nations?"** and **"What was the extent to which the Allies shared the responsibility?"**, of **"How could the Jews, through their own leaders, cooperate in their own destruction?"** and **"Why did they go to their death like lambs to the slaughter?"**—be left in abeyance. Justice insists on the importance of Adolf Eichmann, the man in the glass booth built for his protection: medium-sized, slender, middle-aged, with receding hair, ill-fitting teeth, and nearsighted eyes, who throughout the trial keeps craning his scraggy neck toward the bench (not once does he turn to face the audience), and who desperately tries to maintain his self-control—and mostly succeeds, despite a nervous tic, to which his mouth must have become subject long before this trial started. **On trial are his deeds**, not the sufferings of the Jews, not the German people or mankind, not even anti-Semitism and racism."

The Labour party and Green women will ever learn or develop - **they are stuck** in smug, smart-arse adolescence of privileged pampered, complacent women who have grown up in a time and place of wealth and prosperity. Many have come from universities with a "Manifesto for humanity" under their *pignorant*, smug, smart-arse arms as they have learned to walk on two legs - they can now rule the world. This allows them to lie, abuse and bully others and corrupt all the legislation for the "cause". Like all women in Australian - they are encouraged by government, school, media, charities, health professionals and courts - to lie all the time (no consequence) and completely invent stories. They attack others constantly and declare themselves as "the constant victim" in a **binary certain** way.

No proportion of accountability or responsibility belongs to them. See Proportion

<https://humanistman.com/wp-content/uploads/2019/03/08-Humanism-Meta-Frames-Proportion.pdf>

They are supported by their sentient pet men - **desperately rushing** to **demonstrate their faith to the feminist cause** by castrating themselves of anything which might allow them to learn and develop anything to do with humanity. Very similar to the decline of the Roman Empire and the behavior of **Gallus Ceasar** and his cronies and sycophants - see reports from **Ammianus Marcellinus** - Lifespan[330 to 400] Born_Loc(Antioch, Turkey) Rank(40) Keyword(Soldier, Historian)
https://en.wikipedia.org/wiki/Ammianus_Marcellinus <https://www.gutenberg.org/ebooks/28587>
<https://penelope.uchicago.edu/Thayer/E/Roman/Texts/Ammian/home.html>

Whenever Penny Wong, Russian tyrants, Chinese dictators or the others like her speak - it is not only inauthentic - **it is deluded** - she has deluded herself that if she declares something publicly and loudly and tricks herself into believing it - then others will believe it too. Delusion *“When it rains again - it will never rain enough to fill our dams - it is a climate catastrophe - I declare the truth” “the Sky is really falling - I am the soothsayer of our time” “What we should be doing is what I tell you to do - shame on you if you don’t”*

I believe everything I say - you must too or I will bully you into submission.

Drink the Cool-aid followers - I will give you certainty and utopia via my vainglorious existence.

None of these deluded psychopaths can be trusted with anything.

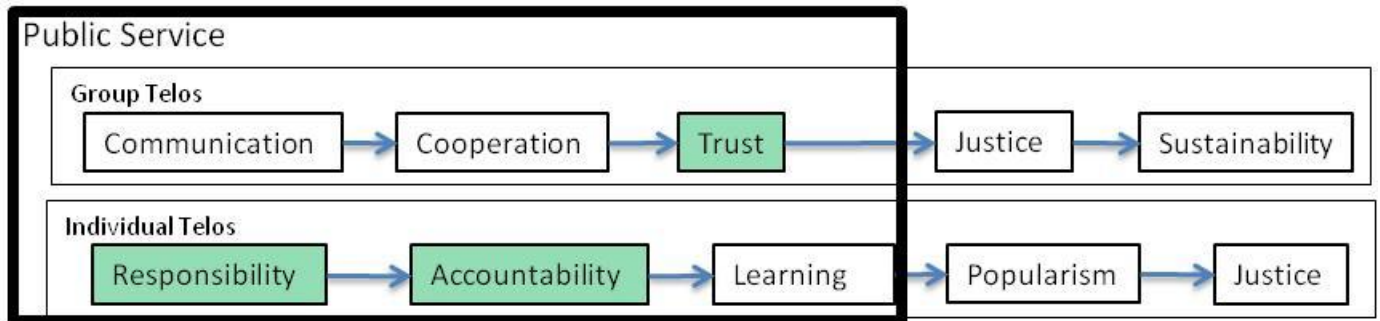

When you see Penny Wong, Feminists, Chinese and Russian Tyrannical dictators - I ask myself:

“Is there such a thing as a well-meaning delusional psychopath?”

Hitler “meant well” ??? Stalin “meant well”. Penny “meant well”, Violent, man-hating, Feminists “meant well”. ABC “means well” “Magistrates support **good causes**”. Lies, abuse, bullying, corruption - the **CERTAIN ends** justifies the **MEANS** doesn’t it??? The **CAUSE** is great!

Did they all “mean well”? Is that the problem with virtue? - The lesson we all know “The road to Hell” , etc? Or was it a simple ruse to hide their bad acting?

A culture of false or improvable allegations

In Australia, women are encouraged to constantly make allegations against specific men or men in general. Domestic Violence laws, Media (ABC, SBS, Guardian, Seven, etc), Family Law, universities, schools, public service, “Independent Research” surveys, politics, commissions of enquiry, public service registers, charities, etc. This establishes a constant victim narrative which entitles (**entitled victim - not responsible** or **accountable** in any way) them to attention (the narcissistic psychopaths), money, free housing, free money, free leave from work, sympathy, fame, public service jobs, made up jobs as “diversity and inclusion officers”, university grants and many public services. This is encouraged by feminists (Greens and Labour party women), women (on average) and weak-minded men (simpletons - the gormless hero for the damsel in distress - or the Cuttlefish men pretending to be a woman so they can get sex (see Douglass Murray’s explanation)) and the legal (scum) community - especially lawyers, barristers, registrars, magistrates and judges in places like Canberra, Melbourne especially but in most places in Australia. Police encourage people to come forward and make false allegations against specific targets and corrupt the legal process as much as they can in Melbourne (Gobbo, Cardinal George Pell), Canberra, Darwin and most places in Australia. This is done corruptly for political, financial or other purposes. It is wise to mistrust the police - they have guns and manufacture evidence and know criminals very well. **Donald Mackay** <https://www.smh.com.au/opinion/organised-crime-thrives-40-years-after-the-donald-mackay-murder-20170709-gx7sg4.html>, **Colin Winchester**, etc.

In Canberra and other Australian courts women declare and sign documents containing false allegations and deliberate lies - especially in domestic violence cases and family law. Even the most outrageous lies are treated as truth or partial truth by judges and they are never tested. The issue is never treated as women lying - it is always treated as a partial complete truth against a man. So the **crime of making false allegations and swearing false affidavits is ignored by Magistrates**. This has been going on for 50 years. There is **never any consequence for a woman making false allegations** - (They become “celebrities” rewarded by government and media) - only the damage to the man who has false allegations made against him. The ABC, Guardian and all media organizations, universities, schools, public service, politics, etc - cooperate in this process to undermine the rule of law based on vigilante journalism usually run by feminist, binary extremists, women (on average - quotas, groupthink) and weak mind men playing “hero” for their virtue.

The ABC, via Leigh Sales, declares on TV “*where there is smoke there is fire*” as their editorial policy - thereby justifying airing publicly a series of vague allegations as an important issue” I don’t like him” “I felt afraid” “ He’s mean” ‘He mistreated me” “I was kicked out of bed when we were having an affair” - the accusers become the hero/victim the ABC declare allegations as fact to demonize anyone they target. This is how domestic violence and family law works - **allegation** - (“*believe all women*” (**unless the allegations are against a woman**)) - the mere vague statement of “**fear**” is enough for men to be attacked, demonized and found guilty. This is the editorial policy of the ABC and the **formal legislation** (family law, domestic violence, discrimination (18C),etc” of the governments, universities, schools, public services, police, courts, etc supported by feminists and weak minded men.

There is no trust or integrality in courts run by feminists and white ribbon causes - where judges are appointed based on identity and virtue signaling - and we see the high court dominated by dim-witted binary thinking feminists and weak minded men - the whole of the legal community is corrupted and continues to decline based on radical feminism, identity politics (*isn't about time we had a homosexual Judge?*), greed and smug virtue signaling as we see in this public letter from 500 women (including the radical feminist Helen Watchirs from A.C.T .Human rights) <https://humanistman.com/wp-content/uploads/2020/07/Women-Lawyers-Corruption-Feminism-Debate.pdf> , <https://womensagenda.com.au/latest/deep-cultural-shifts-required-open-letter-from-500-legal-women-calls-for-reform-of-way-judges-are-appointed-and-disciplined/>

Tribal Entitled/Victim Groupthink Focus destroys Nations

For many decades it was the constant Jew focus - Jews were the tribe deserving the constant victim status and focus of everyone's attention all the time. The **permanent entitled/virtuous/victim narrative**. This dates back thousands of years. Then it was the Blacks. Then Women. It differs in many places but the technique is to establish a tribe based on skin colour, gender, **belief** or other identity features, claim special group status (tribal), demand and cajole others - usually using the shaming, blaming technique of designated "Others" to get constant attention and more money - by positioning. This becomes a feedback loop as the dominate tribe gets more attention and money until the whole system is fully corrupt and unable to escape the constant "special" narrative - special "victim" - special "entitled". This becomes fully entrenched in the schools, media, courts and public services until the idea of nation is destroyed and replaced by fully tribal narratives. We see some of this type of behaviour as recorded by:

John bar Penkaye - Lifespan[610 to 692] Born_Loc(Fenek, Turkey) Rank(20) Keyword(Religion, History) https://en.wikipedia.org/wiki/John_bar_Penkaye
https://www.tertullian.org/fathers/john_bar_penkaye_history_00_eintro.htm
https://www.tertullian.org/fathers/john_bar_penkaye_history_15_trans.htm

*"But once peace was restored and Christian kings had taken over the reins of government of the Romans, then vice and scandal entered the Church, and synods and **sects multiplied**, because **every year someone invented a new creed**. **Security and peace led to many evils**. The **lovers of glory stirred up troubles unceasingly**, using gold to obtain the consent of kings, so they could **play about with them like little children**. All this happened among the Romans."*

John bar Penkaye shows history just prior to the Muslim conquest in the 700's and he describes in detail the collapse of civilization around him - the entitled ruler class - doing and saying the same kinds of things we see today. There is no shortage of **vainglorious, driveling, idiots** through history - willing to puff themselves up with other people's money, destroy all things and smugly sneer and snark about it. Much of this history is available to read on the internet due to the work of one man - **Roger Pearse** and his work over many years <https://www.tertullian.org/rpearse/>

There is no “National Debate” - it is all about tribes debating each other - only special tribes are allowed into the national tribal debate (the elites - special entitled/special victim) - “others” are excluded. With “respect” you must leave the room.

There is no debate about “**The Nation**” - what the nation should do, what kind of nation the people want - only the tribal victim and special entitled tribal narratives.

Nation flags and songs are replaced with tribal dances, ceremonies, sacrifices, flags and songs - tribes replace the nation at every level. Tribal public TV stations, Tribal public services, etc. National ceremonies are trashed and destroyed to be replaced with Tribes and victim groups lead by heroic virtue signaler mobs.

Sometimes this is celebrated as “diversity” or “inclusion” and seen as “a virtue” a “goodness” - without ever exploring the issue of humanity and the more complex issues of nations. Usually pig-ignorant and binary types rush to simple answers to complex problems - feminists, socialists, communists, women (on average - quotas, “respect”), weak- minded men and children. The legal class and other “specialists” - the grafters and profiteers encourage this to improve their own profits. In this way the mobs are encouraged to be deliberately pig-ignorant and more tribal - being dim-witted and uneducated is seen as a virtue in it’s own right - people **violently double down** on their own virtue.

“Well I don’t know about that - but I do know how right I am - have you seen the size of my virtue?”

Positioning For Violence and Control

The idiocy of the USA, Canada, Australia, NZ, UK and other countries is on **vainglorious full time public display** as dimwits like celebrities, princesses, commentators, media, politicians - all demonstrate how determinedly pig-ignorant, corrupt, biased and under-developed they are as human beings. The Human Condition.

This constant idiotic public display - and a lack of opposition to it (the lack of debate) - particularly by USA, UK, Canada, NZ, Australia, Germany and Nordic countries - is seen as a failing by many countries who observe “others”. China and Russia use this **displayed idiocy**, incoherence, corruption, violence and abuse displayed by feminists, virtue signalers, politicians, companies, “elites”, etc - to reinforce their own world view and policies - their own “cultural” superiority in the HUMAN CONDITION.

Once you smugly **position yourself as the superior human** or **superior human group** - then **ALL KINDS OF VIOLENCE CAN FLOW FROM IT**. It becomes “deserved”, “entitled” and “justice”.

One of the MOST IMPORTANT things any country can do to be considered a world leader or exemplar - is to do just that - SET AN EXAMPLE.

“now is the time for all good men to come to the aid of the party”

https://en.wikipedia.org/wiki/Filler_text (Learning to use a typewriter)

One the most **significant threats to Australia's security** by attack from others - is to be seen as the idiots we are - the failed humans - the failed nation - feminist controlled, virtue signaling, celebrity domination, weak minded and determinedly pig ignorant of the human condition.

Undeserving humans (abusive greedy scum we see in feminists, identity politics, **entitled victim narratives**, legal community, courts, politics, business, public services, schools and universities) **can be easily destroyed** by others who want to **exhibit their "morals" and "ethics"** and "save the planet" from the corrupt, underdeveloped, greedy, self-centered (corrupt), **abusers of others** and humanity itself.

In other words - the exact behavior we see from feminists, communists, binary extremists, politicians, abusive mobs - **can easily be reversed ONTO THEM** using similar "Moral" and "Ethical" arguments.

Abstraction - Zoom - Granularity - Avoiding the Binary Certain Dogma

This is important - wake up and notice. Be Sufficiently Vague - Zoom and Focus - Gender instead of male/female

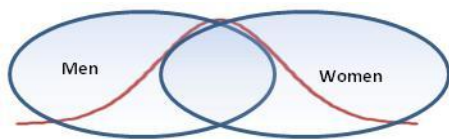

I was talking to a friend and she told me that most people don't understand complexity and then explained the Venn diagram of identity characteristics. She had been called names - labeled as a "cis-type" by some in her community.

I explained that they were binary thinkers using binary concepts and less than 30% of humans can overcome this bias - even if they work hard on it.

She did not understand how a Venn diagram could be binary so I had several goes at explaining the continuum. She saw Venn diagrams as the limit of complexity.

What is inside the circle "Women" - what then, is outside the circle, "men"? - NO its not - it is "Not Women". What is outside the circle within the box? Continuum - everything.

I documented all this in many places but most recently in **Equality Diversity Proportion Value Trust** <https://humanistman.com/wp-content/uploads/2021/05/Equality-Diversity-Proportion-Value-Trust.pdf> and **Gender** <https://humanistman.com/wp-content/uploads/2021/06/Gender.pdf>

	<p>Binaries do not understand that this is binary thinking. They think this is complexity. This is the extent of their cognitive abilities in definition and abstraction.</p>
--	---

A different way of looking at this is to start with a concept at a sufficiently vague or higher level of abstraction. To do this you start at low levels of fact and **push upwards towards higher level of abstractions**. This **is** a thinking and analysis technique - finding the right level of abstraction. **Finding the right (Utility) level of Zoom and Focus**. This means it will be a useful level of abstraction and a level where it generally encompasses all the usual day to day requirements without **having to be argued and amended all the time** - it has **some** robustness, coherence, cohesiveness and longevity - it is architected to survive the tsunamis and earthquakes - it can withstand - and should withstand - constant testing, debate and discussion.

See **Equality – Diversity – Measurement – Notice** <https://humanistman.com/wp-content/uploads/2020/08/Equality-Diversity-Measurement-Notice.pdf> , Measuring and noticing things at the “right” level.

This becomes a different approach to lawyer and binary types who insist on expensive excruciating dogmatic certainty (for their own profit and certainty) - Pharisees and Scribes.

The other issue worth noting is the general problem of push back against any declared thing. Think the Black Obelisk in Arthur C Clarke’s 2001: A Space Odyssey. **Once a thing is declared** - it is there to be pushed back against, argued, examined and explored - so the general idea is to find things which fit well within the shared group schemas.

Sufficiently certain - sufficiently vague. On a continuum.

So instead of saying there are concepts of things like Male and Female - you say there is a concept of gender based differences on a continuum - or shorthand “**Gender Continuum**” for **most human characteristics**. A lower level of abstraction shows **several specific places where Gender matters** in a shared society - biological reproductive sex - Male/Female, Toilets and Sport. These are the **limited number of specific places** we define in shared society schemas - rather than a complete legal dogmatic enumeration and definition of everything.

Here is how babies are made. - Here is where you go to the toilet - here is the sport you play by gender - Societal variable schemas sometimes explored, discussed and debated- not legislated mandates.

In the **vast majority of life - GENDER makes no difference!** - Even clothes can be worn at different times - based on preference, situation and societal norms - **not legislated dogma**. Gender is irrelevant for doing any job - it is based on skills, capability, interest, etc. If you do not have the capabilities, skills and interest in a job there may be many factors involved - making these factors a **groupthink/victim narrative is a resentful tendency of weak minded binary thinkers, etc.**

So the “**RIGHT**” - **useful/sensible/cohesive/coherent/comprehensive** - level for abstraction for jobs is competency, capability (knowledge, experience and skills), capacity, interest - not a **hypocrite**, not a **coward** (not facing your fears), not **self centered**, not **virtue signaling** and not **bad actor**. i.e. not corrupt. These are continuums and not binary - it is complex.

So **GENDER** or **RACE** is exactly the **WRONG thing to focus on** when looking at jobs. But this is what Binary certain idiots do - all the **binary extremists** do this - communists, fascists, religious zealots, feminists, women on average (quotas, average wages), weak minded men - the **choose the wrong thing** like Race, Gender, Belief, political party, etc - a **deliberate corruption** - the **very definition of corruption** for public jobs and money. So instead of saying a fireman has to be able to lift 100 kilogram body out of a burning building or hold a hose full of water - they say this discriminates against women - when in reality all it does is discriminate against those humans who cannot lift 100 kilogram body. In science you have to be clever and pass tests. Males do better than females (on average) so they say this discriminates against women or blacks or idiots (on average) - when in reality all it discriminates against is those humans who cannot pass the test. So they **lower the standards** of the tests so scientist's standards drop, etc. You need some intelligence in the public service - but this allegedly discriminates against females - so they invent *emotional intelligence* as a selection criteria so unintelligent females can be "included" in an **inclusive** way that the Labour and Green champion for lowering the standards of everything. This is the opposite of **working to one's strengths and capabilities (building excellence in your area of skills, interest and capabilities)** - instead of **destroying standards in everything else (based on the resentful entitled victim of discrimination)** - a **race to the bottom** kind of thing based on an **AVERAGE view of things** rather than an **EXCELLENCE view of things**. Driven by **resentment**.

This **Wrong focus** - has it's origins in the weak - the weak minded, insecure and incompetent. This is why schools need to encourage all children to find something they enjoy and can feel proud of (**self confidence** - **NOT virtue signaling**) - rather than demonizing and grouping. The weak - generally the little girls in the playground - start playing little group games where they exclude "others". They practice being "special" with signs, clothes, insignia, attitudes, whispers, words, language, songs - anything which build cohesion within their group. So we have boys and girls gangs. They say thing like we exclude people called "homer", tall people, ugly people or people "we" do not like - they practice **exclusion games** and start defining characteristics for their little special groups - the **mean girls** enjoy their **smug feelings of power** when they abuse and belittle others. They like the reaction when they declare that others are "excluded" from their special group. Some special groups do not even wait to be asked - they straight away go around pointing at others, demonizing and belittling them and publicly declare they are excluded" as a constant put-down and abuse. They become teachers, scolders and demonizers of "others" (diversity and inclusion officers, human rights, etc) .They then control what characteristics define the "in-group" as they see it with smug certainty. i.e. the **WRONG** things for humanity (to be debated and **we hate debate**) but the **RIGHT** things for our special in-group.

Many take this behaviour into adulthood - into gangs, motorcycle clubs, politics, law and political staffers - **playing exclusion games** and **narcissistic power trips** by demonizing others. For many this is only a **right of passage** (trying to build some self-confidence by putting other people down) into **becoming a responsible adult**. Some skip the games altogether and go straight to responsible individual adult.

This is documented in many places - mafia, crime gangs, tribes - See **Lord of the Flies**

https://en.wikipedia.org/wiki/Lord_of_the_Flies, **West Side Story**

https://en.wikipedia.org/wiki/West_Side_Story, **Trainspotting**

[https://en.wikipedia.org/wiki/Trainspotting_\(film\)](https://en.wikipedia.org/wiki/Trainspotting_(film)), **A Clockwork Orange**

[https://en.wikipedia.org/wiki/A_Clockwork_Orange_\(film\)](https://en.wikipedia.org/wiki/A_Clockwork_Orange_(film))

How to destroy society and the public service.

I explored this in many places but in detail in **15-Humanism-Corruption-Nation-Choice-Virtue**

<https://humanistman.com/wp-content/uploads/2020/04/15-Humanism-Corruption-Nation-Choice-Virtue.pdf> (page 35)

Corruption – Where I draw the line

Human Population by characteristics, percentage engaged in Public Service
Decisions and activities – Government, Courts, Police, Public Service, etc.

I rate **Bad Actors** (almost binary, absolute, extreme) the worst but unavoidable – they always need to be observed and managed. **Virtue signalers** are next because they make decisions for wrong reasons.

Hypocrisy next shows the system in breakdown – incoherent or incomprehensive - biased.

Systems changes and development need to be done openly and without an environment of fear and punishment.

Note: Skills (competence) and knowledge (not ignorant) is over a wide range – allows variation, diversity, sharing and development.

As things degenerate with corruption - **capacity** fails early (after **bad actor** and **virtue**), followed by **hypocrisy** and **fear**. Then **self interest**, **disinterest**, **competency** and **ignorance**.

A high level of ignorance or incompetence in society is a later stage sign of a collapse and corruption.

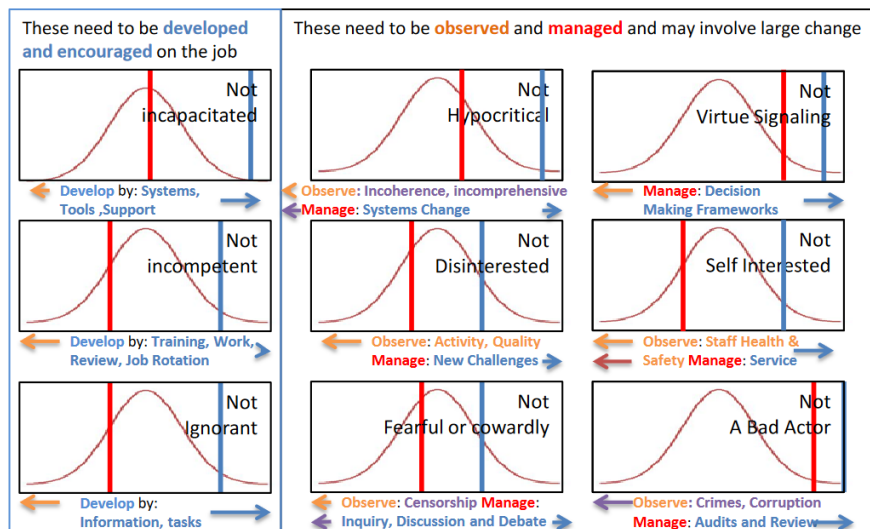
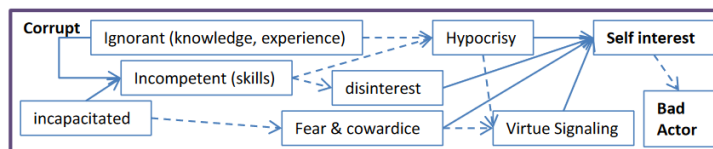
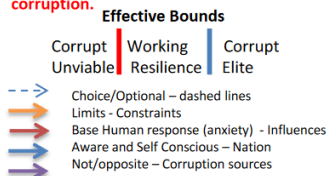

Skin colour, beliefs, gender are the **WRONG** levels of abstraction for a job. **You will not get the best human.**

Here is (below) what binaries think is the **current gender debate**. Everything (attraction, clothing, reproduction, surgery) is mixed up - binary and not abstracted to a useful level (John Mills utility) for our societies shared schemas - it is in-coherent, incomplete (and will always be) and nonsense. They call it **“non-Binary”** when in-fact it is **ALL BINARY**. It is a poorly focused model in coherence and comprehension.

It is a **nonsense debate** about identity which is the **least interesting** thing about **being human**. (I am paraphrasing a notable black woman and many others who want to be **treated like a human** rather than

as a **Token for some group mob vigilante cause** - stop using me as a token for your hate-filled mob cause)

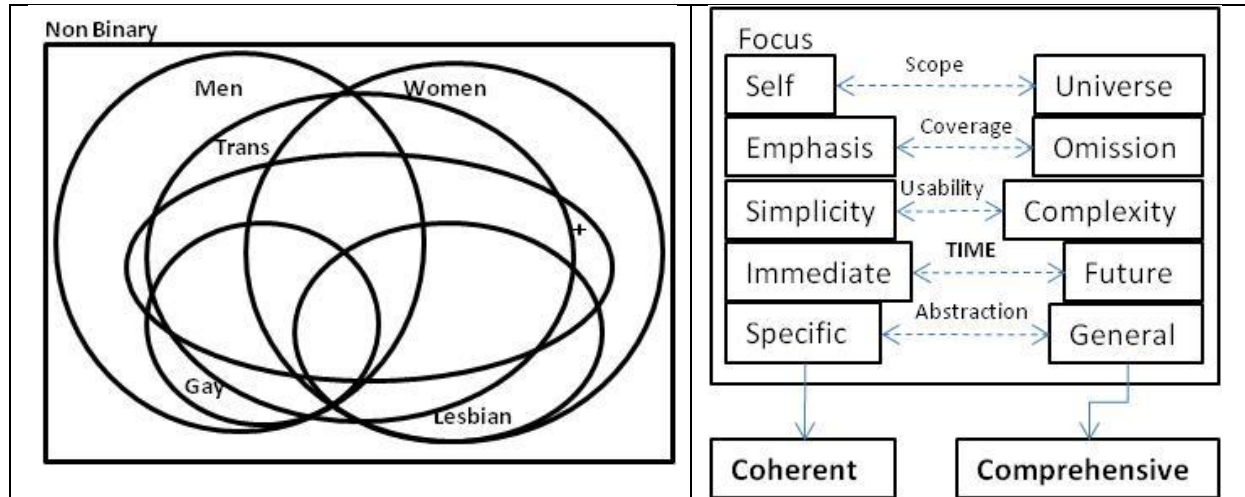

Chronicles from the End of Civilization

Notes From The Underground - Document[1864] Rank(30) Author(**Fyodor Dostoevsky**) Age(43)
Keyword(Group Development Humanism) https://en.wikipedia.org/wiki/Notes_from_Underground
<https://www.planetebook.com/notes-from-the-underground/>
<http://www.gutenberg.org/ebooks/author/314>

Good writers write when there is something to write about. Usually it is something they see as **important to humanity**. Usually older, experienced men with awareness, skills, capability and an ability to hypothesize, explore, communicate and debate. There are messages throughout history in all these types of books. Thousands of thinkers and writers at every age of history who represent a small proportion of the mobs that surround them at their time in history.

Fat, Dumb, Lazy and complacent humans fail to notice things. The Siren calls of virtue and goodness delude their senses and view of the world. Anxiety and Terror threaten, Utopia begs - the Final solution, not the Human condition. The Elephants gather in room and the binary thinkers attack the thinkers who dare to notice or question. We are Safe and Smug - stop attacking us. The Mobs grow, resentment, anger, self-righteous abuse, demonization of others and anger - the laws and system become more corrupt. The Education system, media, books and records are burned and destroyed - shaped into causes for the elites. War becomes the quick solution to the complex problems. The ABC encourages "let us burn this place down" as the mob finally realizes its own stupidity.

Recent Documents

Human, All too Human - Document[1878] Rank(10) Author(**Friedrich Wilhelm Nietzsche**) Age(34)
Keyword(Individual Philosophy Morals) <http://www.gutenberg.org/files/38145/38145-h/38145-h.htm>
https://en.wikipedia.org/wiki/Friedrich_Nietzsche
https://digitalassets.lib.berkeley.edu/main/b20790001_v_1_B000773557.pdf

https://onemorelibrary.com/index.php/en/?option=com_djclassifieds&format=raw&view=download&task=download&fid=3367 <https://holybooks.com/human-all-too-human-nietzsche-ebook/>

At age 34 he is becoming a man and starting to escape the strong influences on him. He is thinking for himself more now. He has seen the Greeks, Death, War, University and great art. We see him trying to escape the influences on the individual human and discover humanity as a concept. This aligns with <https://humanistman.com/wp-content/uploads/2020/04/15-Humanism-Corruption-Nation-Choice-Virtue.pdf> the model on page 27 which is about escaping from **3. Self Focused and positioning by others** (Typically the child) , **2. Self Positioning for Others** (The middle aged working for others and virtue signaling) and becoming A “Free Spirit” (in Nietzsche’s terminology) **1. Not for Self or Others** (A Human).

He is also of a time when people read books - they sought out information and debate. They were **not driven by instant feedback** using radio, TV or Internet. They were prepared to investigate and learn.

*“Perhaps I could be fairly reproached with much “art” in this regard, many fine counterfeitings; for example, that, wisely or wilfully, I had **shut my eyes** to Schopenhauer’s blind will towards ethic, at a time when I was **already clear sighted enough** on the subject of ethic; likewise that **I had deceived myself** concerning Richard Wagner’s incurable romanticism,[7] **as if it were a beginning and not an end**; likewise concerning the Greeks, likewise concerning the Germans and their future—and there may be, perhaps, a long list of such likewises. Granted, however, that all this were true, and with justice urged against me, what does it signify, what can it signify in regard to how much of the self-sustaining capacity, how much of reason and higher protection are embraced in such self-deception?—and **how much more falsity is still necessary to me that I may therewith always reassure myself regarding the luxury of my truth**. Enough, I still live; and life is not considered now apart from ethic; it will [have] deception; it thrives (lebt) on deception ... but am I not beginning to do all over again what I have always done, I, the old immoralist, and bird snarer—talk unmorally, ultramorally, “beyond good and evil”?”*

*“Thus, then, have I evolved for myself the “free spirits” to whom this **discouraging-encouraging** work, under the general title “Human, All Too Human,” is dedicated. **Such “free spirits” do not really exist and never did exist. But I stood in need of them**, as I have pointed out, in order that some good might be mixed with **my[8] evils** (illness, loneliness, strangeness, acedia, incapacity): to **serve as gay spirits and comrades**, with whom one may talk and laugh when one is disposed to talk and laugh, and whom one may send to the devil when they grow wearisome. They are some compensation for the lack of friends. **That such free spirits can possibly exist**, that our Europe will yet number among her sons of to-morrow or of the day after to-morrow, **such a brilliant and enthusiastic company, alive and palpable and not merely, as in my case, fantasies and imaginary shades**, I, myself, can by no means doubt. I see them already coming, **slowly, slowly**. **May it not be that I am doing a little something to expedite their coming when I describe in advance the influences under which I see them evolving and the ways along which they travel?”***

The Traditional Error of Philosophers.—All philosophers make the common mistake of taking contemporary man as their starting point and of trying, through an analysis of him, to[21] reach a

conclusion. "Man" involuntarily presents himself to them as an aeterna veritas as a passive element in every hurly-burly, as a fixed standard of things. Yet everything uttered by the philosopher on the subject of man is, in the last resort, nothing more than a piece of testimony concerning man during a very **limited period of time. Lack of the historical sense is the traditional defect in all philosophers.** Many innocently take man in his most childish state as fashioned through the influence of certain religious and even of certain political developments, as the permanent form under which man must be viewed. **They will not learn that man has evolved,**⁴ that the **intellectual faculty itself is an evolution**, whereas some philosophers make the whole cosmos out of this intellectual faculty. But everything essential in human evolution took place aeons ago, long before the four thousand years or so of which we know anything: during these man may not have changed very much. However, the philosopher ascribes "instinct" to contemporary man and assumes that this is one of the unalterable facts regarding man himself, and hence affords a clue to the understanding of the universe in general. The whole teleology is so planned that man during the last four thousand years shall be spoken of as a being existing [22]from all eternity, and with reference to whom everything in the cosmos from its very inception is naturally ordered. Yet everything evolved: there are no eternal facts as there are no absolute truths. Accordingly, historical philosophising is henceforth indispensable, and with it honesty of judgment.

A wider focus model can help frame explorations of philosophy. See all my frames.

Dream and Civilization.—The function of the brain which is most encroached upon in slumber is the memory; not that it is wholly suspended, but it is **reduced to a state of imperfection as, in primitive ages of mankind**, was probably the case with everyone, whether waking or sleeping. Uncontrolled and entangled as it is, it perpetually confuses things as a result of the most trifling similarities, yet in the same mental confusion and lack of control the nations invented their mythologies, while nowadays **travelers habitually observe how prone the savage is to forgetfulness, how his mind, after the least exertion of memory, begins to wander and lose itself until finally he utters falsehood and nonsense from sheer exhaustion.** Yet, in dreams, we all resemble this savage. Inadequacy of distinction and error of comparison are the basis of[32] the preposterous things we do and say in dreams, so that when we clearly recall a dream **we are startled that so much idiocy lurks within us.** The absolute distinctness of all dream-images, due to implicit faith in their substantial reality, recalls the conditions in which **earlier mankind** were placed, for whom **hallucinations had extraordinary vividness**, entire communities and **even entire nations laboring simultaneously under them.** Therefore: in sleep and in dream **we make the pilgrimage of early mankind over again."**

Fat, Dumb and Lazy uncivilized people prefer easy delusion to any reality - no matter much how violence, death or destruction is involved. Remember Merv/Mary and Genghis Khan - **rivers of blood** for my delusions.

Scepticism and Animal Faith - Document[1923] Rank(80) Author(**George Santayana**) Age(60)

Keyword(Group Development Philosophy)

https://openlibrary.org/books/OL7090938M/Scepticism_and_animal_faith

https://en.wikipedia.org/wiki/Scepticism_and_Animal_Faith

<https://archive.org/details/scepticismandani00santuoft/page/n5/mode/2up>

The Realms of Being - Document[1942] Rank(80) Author(**George Santayana**) Age(79) Keyword(Group Development Philosophy) https://en.wikipedia.org/wiki/The_Realms_of_Being
<https://iep.utm.edu/santayan/> <https://santayana.iupui.edu/>

The Life of Reason - Document[1906] Rank(20) Author(George Santayana) Age(43) Keyword(Group Development Philosophy) https://en.wikipedia.org/wiki/The_Life_of_Reason
<https://www.gutenberg.org/files/15000/15000-h/15000-h.htm> <https://santayana.iupui.edu/text/>

Recent People

Numa Pompilius - Lifespan[-753 to -674] Born_Loc(Cures, Sabinum, Italy) Rank(80) Keyword(Politics, Law, King) <https://www.romanoimpero.com/search?q=Numa+Pompilius>
https://en.wikipedia.org/wiki/Numa_Pompilius
https://penelope.uchicago.edu/Thayer/e/roman/texts/plutarch/lives/numa*.html

*"It was for the most part by sacrifices, processions, and religious dances, which he himself appointed and conducted, and which mingled with their solemnity a **diversion full of charm** and a beneficent pleasure, that he won the people's favour and tamed their fierce and warlike tempers. At times, also, by **heralding to them vague terrors from the god**, strange apparitions of divine beings and **threatening voices**, he would **subdue and humble** p333 their minds by means of **superstitious fears**. 4 This was the chief reason why Numa's wisdom and culture were said to have been due to his intimacy with the Pythagoreans; for in the philosophy of the one, and in the civil polity of the other, religious services and occasions have a large place. It is said also that the **solemnity of his outward demeanour** was adopted by him because he shared the feelings of Pythagoras about it. 5 That philosopher, indeed, is thought to have tamed an eagle, which he stopped by certain cries of his, and brought down from his lofty flight; also to have disclosed his golden thigh as he passed through the assembled throngs at Olympia. And we have reports of other devices and performances of his which savoured of the marvellous, regarding which Timon the Phliasian wrote:—*

*"Down to a juggler's level he sinks with his **cheating devices**, Laying his nets for men, Pythagoras, lover of bombast."*

George Santayana/Jorge Agustín Nicolás Ruiz de Santayana y Borrás - Lifespan[1863 to 1952] Born_Loc(Madrid, Spain) Rank(80) Keyword(Philosophy)
https://en.wikipedia.org/wiki/George_Santayana <https://www.gutenberg.org/files/15000/15000-h/15000-h.htm> https://en.wikiquote.org/wiki/George_Santayana

References

1. https://en.wikipedia.org/wiki/De_Oratore *"In my opinion, indeed, no man can be an orator possessed of every praiseworthy accomplishment, unless he has attained the knowledge of everything important, and of all liberal arts, for his language must be ornate and copious from*

knowledge, since, unless there be beneath the surface matter understood and felt by the speaker, oratory becomes an empty and almost puerile flow of words. [21] Yet I will not lay so great a burden upon orators, especially our own, amid so many occupations of public and private life, as to think it allowable for them to be ignorant of nothing; although the qualifications of an orator, and his very profession of speaking well, seem to undertake and promise that he can discourse gracefully and copiously on whatever subject is proposed to him."

2. https://penelope.uchicago.edu/Thayer/E/Roman/Texts/Diodorus_Siculus/1A*.html "17 1 Of Osiris they say that, being of a beneficent turn of mind, and eager for glory, he gathered together a great army, with the intention of visiting all the inhabited earth and **teaching the race of men how to cultivate the vine and sow wheat and barley**; 2 for he supposed that if he made **men give up their savagery and adopt a gentle manner of life he would receive immortal honours because of the magnitude of his benefactions**. And this did in fact take place, since not only the men of his time who received his gift, but all succeeding generations as well, because of the **delight which they take in the foods which were discovered**, have honoured those who introduced them as gods most illustrious.'..” For it is at **Thonis**, as it is called, which in early times was the trading-port of Egypt, that the river empties into the sea. Its last name and that which the river now bears it received from the former king **Nileus**.”
3. https://penelope.uchicago.edu/Thayer/E/Roman/Texts/Diodorus_Siculus/1D*.html#84 84 1 But if what has been said seems to many incredible and like a fanciful tale, what is to follow will appear far more extraordinary. Once, they say, when the inhabitants of Egypt were being hard pressed by a famine, many in their need laid hands upon their fellows, yet not a single man was even accused of having partaken of the **sacred animals**. 2 Furthermore, whenever a dog is found dead in any house, every inmate of it shaves his entire body and goes into mourning, and what is more astonishing than this, if any wine or grain or any other thing necessary to life happens to be stored in the building where one of these animals has expired, they would never think of using it thereafter for any purpose. 3 And if they happen to be making a military expedition in another country, they ransom the captive cats and hawks and bring them back to Egypt, and this they do sometimes even when their supply of money p289 for the journey is running short. 4 As for ceremonies connected with the Apis of Memphis, the Mnevis of Heliopolis²⁵ and the goat of Mendes, as well as with the crocodile of the Lake of Moeris, the lion kept in the City of Lions (Leontopolis), as it is called, and many other ceremonies like them, they could easily be described, but the writer would scarcely be believed by any who had not actually witnessed them. 5 For these animals are kept in sacred enclosures and cared for by many men of distinction who offer them the most expensive fare; for they provide, with unfailing regularity, the finest wheaten flour or wheat-groats seethed in milk, every kind of sweetmeat made with honey, and the meat of ducks, either boiled or baked, while for the carnivorous animals birds are caught and thrown to them in abundance, and, in general, great care is given that they have an expensive fare. 6 They are continually bathing the animals in warm water, anointing them with the most precious ointments, and burning before them every kind of fragrant incense; they furnish them with the most expensive coverlets and with splendid jewellery, and exercise the greatest care that they shall enjoy sexual intercourse according to the demands of nature; furthermore, with every animal they keep the most beautiful females of the same genus, which they call his

concubines and attend to at the cost of heavy expense and assiduous service. 7 When any animal dies they mourn for it as deeply as do those who have lost a beloved child, and bury it in a manner not in keeping with their ability but p291 going far beyond the value of their estates. 8 For instance, after the death of Alexander and just subsequently to the taking over of Egypt by Ptolemy the son of Lagus, it happened that the Apis in Memphis died of old age; and the man who was charged with the care of him spent on his burial not only the whole of the very large sum which had been provided for the animal's maintenance, but also borrowed in addition fifty talents²⁶ of silver from Ptolemy. And even in our own day some of the keepers of these animals have spent on their burial not less than one hundred talents.

4. https://penelope.uchicago.edu/Thayer/E/Roman/Texts/Diodorus_Siculus/1A*.html “27 1 The Egyptians also made a law, they say, contrary to the general custom of mankind, permitting men to marry their sisters, this being due to the success attained by Isis in this respect; for she had married her brother Osiris, and upon his death, having taken a vow never to marry another man, she both avenged the murder of her husband and reigned all her days over the land with complete respect for the laws, and, in a word, became the cause of more and greater blessings to all men than any other. 2 It is for these reasons, in fact, that it was ordained that the queen should have greater p87 power and honour than the king and that among private persons the wife should enjoy authority over her husband,⁵⁶ the husbands agreeing in the marriage contract that they will be obedient in all things to their wives.⁵⁷”
5. Greg Ellis on Jordan Peterson podcast <https://www.youtube.com/watch?v=9S60kJA6tic>
6. Ohio Family Law <https://www.ourfamilywizard.com/knowledge-center/regional-resources/united-states/ohio/child-custody-laws-ohio>
7. **John Scotus Erigena** <https://ia801709.us.archive.org/31/items/periphyseon-the-division-of-nature-by-johannes-scotus-erigena-john-joseph-omeara/Periphyseon%20-%20The%20division%20of%20nature%20by%20Johannes%20Scotus%20Erigena%20John%20Joseph%20Omeara.pdf> The first book * deals with God as Source, one who creates but is not created. The second deals with the first or primordial causes, things which are created and themselves create. The third book treats of the created universe which is created, but does not itself create. And the fourth and fifth books deal with God as End, one who does not create and is not created. In this way is expounded the externation or procession or descent of all that is from God, and its return or ascent to him. The return is a reversal of the outgoing process. This fourfold, logical, “division” of things is the source of an alternative title for the Periphyseon, *de diuisione naturae*, the division of nature or of all reality.
8. Minerva <https://en.wikipedia.org/wiki/Minerva>
9. **The History Of My Calamities**/Historia Calamitatum - Document[1132] Rank(60) Author(**Peter Abelard**) Age(53) Keyword(Individual Development Humanism, Autobiography) <https://www.gutenberg.org/cache/epub/14268/pg14268.html> https://en.wikipedia.org/wiki/Historia_Calamitatum <https://sourcebooks.fordham.edu/basis/abelard-histcal.asp>
10. https://www.chabad.org/library/bible_cdo/aid/16101/jewish/Chapter-3.htm 20 And when a righteous man repents of his righteousness and commits injustice, I shall place a stumbling block before him-he will die; if you do not warn him, he will die because of his sin, and his righteous

deeds that he performed will not be remembered, but I shall require his blood from your hand.

21 But you, if you warn him-the righteous man-that a righteous man should not sin, and he does not sin-he will live because he took heed, and you-you will have saved your soul." - This seems to imply the idea of a Righteous Man - someone who is either behaving righteously (Smug, virtue) or is potentially "righteous" - (as an extreme abstract) as a message to avoid sin - but the prophet (Pharisee, Scribe - the boss) - the person who delivers judgement of what is sin or isn't - is Yechezkel - Ezekiel - speaking "god's truth" of certainty - certain NOT - SIN.

11. Brendan O'Neill <https://www.spiked-online.com/2022/03/11/the-end-of-the-age-of-fragility-2/>
12. <https://goodsauce.news/the-death-of-parliamentary-democracy-in-victoria/>
13. **The Evolution of Desire** | **David Buss** | The JBP Podcast | #235 120,638 views Mar 15, 2022
<https://www.youtube.com/watch?v=n9wzSpz7gKE>
14. <https://labs.la.utexas.edu/buss/files/2015/10/buss-1989-sex-differences-in-human-mate-preferences.pdf> , <https://psycnet.apa.org/record/1995-21138-001> ,
https://www.researchgate.net/publication/15471658_Psychological_Sex_Differences_Origins_Through_Sexual_Selection
15. Terror management https://en.wikipedia.org/wiki/Terror_management_theory **Ernest Becker**
https://en.wikipedia.org/wiki/The_Denial_of_Death ,
https://en.wikipedia.org/wiki/Ernest_Becker , <https://johnathanbi.com/book-notes-summaries/the-denial-of-death> *"Transference heroics gives man what he needs, certain degree of uniqueness, a **definite reference point** for his practice of goodness, within a certain secure level of safety and control. But what makes it demeaning is that it is unconscious and reflexive, not fully in one's control."*..*"The plight of the modern individual is characterized by the inability for any of the traditional immortality ideologies to satisfy **one's urge for heroism**. As a consequence, neurosis is more widespread because our defense mechanisms have stopped working and we are **faced with the nihilism of life and death**. Modernity comes with two curses. Firstly, globalization and diversity in thought makes us less sure of the righteousness of our own views. Diversity in ideology is a threat to heroism because the hero must believe that he is on the one true path. Thus, it can be disheartening to see "authorities who are equally unimpeachable hold opposite views."* Secondly, our analytical ability has rendered us cynical, depriving our ability to have faith."
16. Call it Out register <https://callitout.com.au/>
17. Douglas Murray - Spectator <https://www.spectator.co.uk/article/the-west-has-rediscovered-its-purpose>
18. <https://goodsauce.news/equity-is-destructive/> *"Nick Kastelein is a South Australian writer. He writes about politics, philosophy and current events, with an emphasis on applying a Christian worldview, and finding the simplest, truest perspective. You can find more of his past writing at NPKastelein.com ."*
19. Jordan Peterson Q&A At Caius College (University of Cambridge) 70,493 views Apr 4, 2022
<https://www.youtube.com/watch?v=EskHqQ1qm5U> problems with "unrevealed truth"
20. Brendan O'Neill <https://www.spiked-online.com/2022/04/06/now-we-know-just-how-dehumanising-the-nazi-slur-can-be/>

21. Alex Antic <https://www.dailymail.co.uk/news/article-10693815/Australian-health-secretary-Dr-Brendan-Murphy-fails-define-woman.html>
22. Woke white Stanford academic is branded 'Professor Karen' for threatening to call police on black Berkeley professor who opposed her plans to dumb-down the school's math curriculum to boost 'equity' <https://www.dailymail.co.uk/news/article-10697977/Woke-white-Stanford-academic-named-Professor-Karen-threatening-call-cops-black-professor.html>
23. BLM Douglas Murray <https://nypost.com/2022/04/07/black-lives-matter-just-another-racket/>
24. Quadrant article on fragility <https://quadrant.org.au/magazine/2022/04/the-fragility-industrial-complex/>
25. [https://en.wikipedia.org/wiki/Lycurgus_\(lawgiver\)](https://en.wikipedia.org/wiki/Lycurgus_(lawgiver))
26. Carmenta <https://en.wikipedia.org/wiki/Carmenta> ,
<https://www.romanoimpero.com/search?q=Numa+Pompilius>
27. [https://en.wikipedia.org/wiki/Egeria_\(mythology\)](https://en.wikipedia.org/wiki/Egeria_(mythology))